

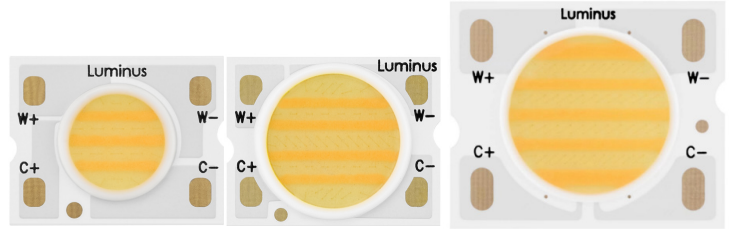

Two-Channel Color Tunable COBs Generation 2



Features:

- Two channel cool and warm 90+ CRI LEDs
- High lumen density for directional lighting
- Enables system beam angles from 10 to 40 degrees
- 6500K to 2700K CCT range for commercial and residential lighting
- Robust design standard COB manufacturing materials and processes
- Consistent white light <3 SDCM
- Specified “hot” performance and 100% factory tested at Tj=85°C
- RoHs and REACH compliant



Applications

- Human centric lighting
- Museum and high-end retail lighting
- Hospitality / hotel / restaurant lighting
- Circadian lighting
- Residential lighting

Contents

Part Number Nomenclature 2
CCT Specification 3
Ordering Part Numbers.... 4
Operating Characteristics .. 5
Optical and Electrical Characteristics 6
Typical Spectrum 21
Mechanical Dimension ... 22
Shipping Container 24
Technology Review 25
Test Specifications 26
Handling Notes 27



Part Number Nomenclature

All Luminus COB products are packaged and labeled with part numbers as outlined in the table on page 4. Luminus may include any smaller chromaticity bin that is contained in the larger bin as part of the ordered part. When shipped, each package will contain only a single flux and chromaticity bin. The part number designation is as follows:

CTM	—	X	—	X	—	90	—	36	—	TWD6	—	F3	—	3
Product Family	LES ¹	CCT ²	Min. CRI ³	Typical Voltage	Package Configurator ⁴	Flux Bin	Chromaticity Bin							
Chip on Board, Multi-die	LES diameter	See Note 2 below	CRI See Table Below	Volts (V)	TWD6	Lumens	See page 3 for bins							

Notes:

1. Light Emitting Surface (LES) Diameter. Luminus provide 6mm, 9mm, 14mm, 18mm and 22mm LES.
2. Correlated Color Temperature (CCT), X nomenclature corresponds to the following:
4018 = 4000K to 1800K
5022 = 5000K to 2200K
6527 = 6500K to 2700K
3. Minimum Color Rendering Index (CRI).
4. TW = tunable, D = dispense technology, 6 = Gen 2
5. Luminus part numbers may be accompanied by prefixes or suffixes. The most common is the “Rev01” suffix indicating a part is fully released and carries a full warranty. These additional characters may appear on shipping labels, packing slips and invoices. In all cases the basic part number described above will always be included.

CCT, CRI and R9 Values

Correlated Color Temperatures	XX Value	CRI	*R9
1800K, 2200K, 2700K, 4000K, 5000K, 6500K	90	>90	>50

Salud Human Centric Product

Luminus offers the 5000K to 2200K product as a human centric version. Leveraging the superior performance of the Salud platform, Luminus has created a two-channel solution that delivers exceptionally high M/P melanopic ratio at 5000K to keep people awake and alert. And the calming version of color at 2200K with very low M/P ratio to encourage rest or sleep. The M/P values are summarized below for the CTM-5022 products. of the 5000K, 2200K part.

CCT Values	Melanopic Ratio M/P Typical Value
2200K	0.35
5000K	0.99

Note: R9 values have a tolerance of +/- 5%



CHROMATICITY BIN STRUCTURE

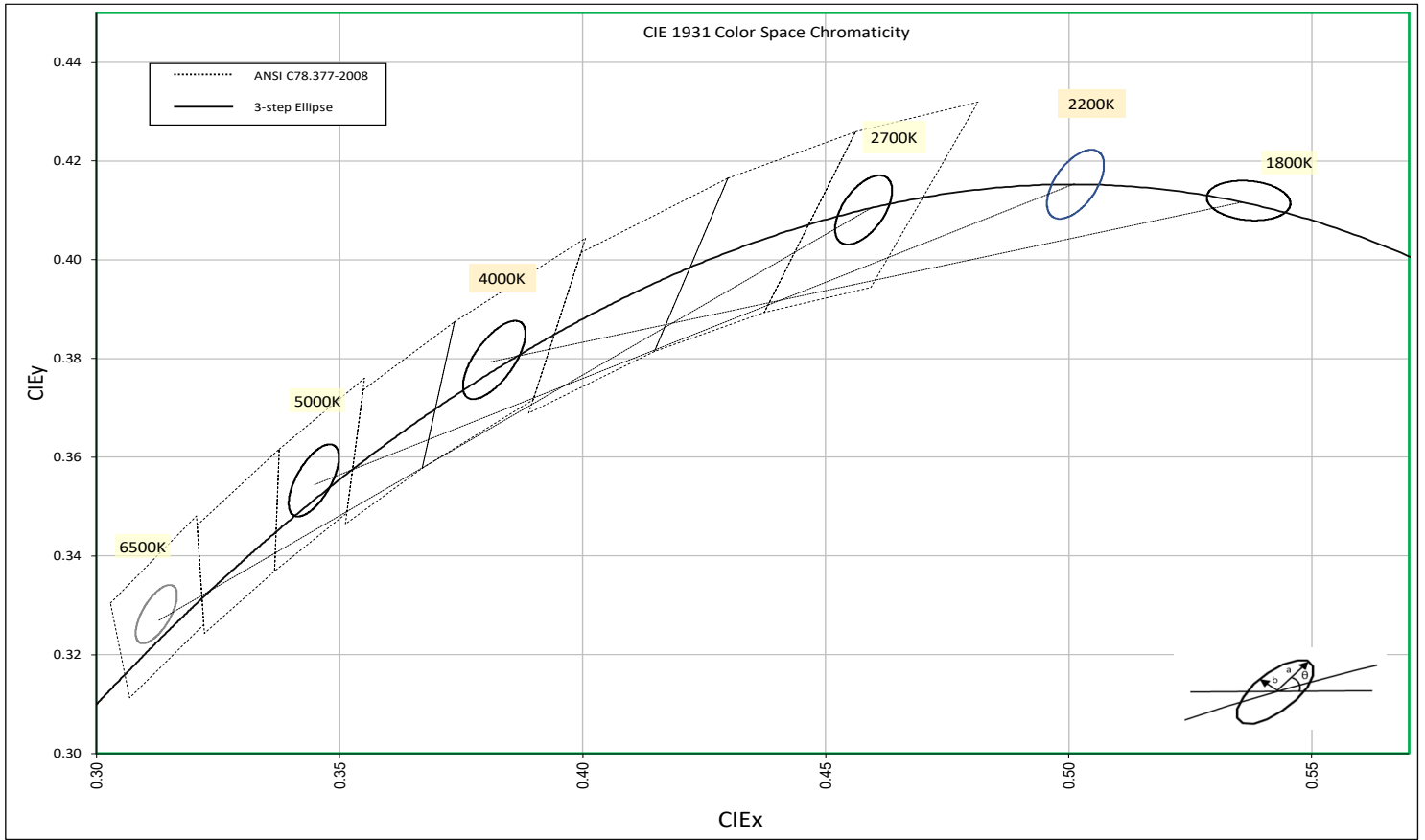

This table defines the chromaticity bin center points, the orientation angle for the MacAdam ellipse (θ°), and the maximum radii for the ellipses. The ANSI Bin is provided in the above graph for reference.

Nominal CCT	Center Point		Angle	3-step bin	
	CIE _x	CIE _y	θ°	a	b
1800K	0.5370	0.4120	-5	0.0086	0.0040
2200K	0.5014	0.4153	53.7	0.0081	0.0042
2700K	0.4578	0.4101	53.7	0.0081	0.0042
4000K	0.3818	0.3797	53.7	0.0094	0.0040
5000K	0.3447	0.3553	59.6	0.0082	0.0035
6500K	0.3123	0.3282	58.57	0.0067	0.0029

Note: Luminus maintains a +/- 0.005 tolerance on chromaticity (CIE_x and CIE_y) measurements



Ordering Part Numbers

The following tables describe products with typical flux and minimum flux measured at current noted and specified at $T_j = 85^\circ\text{C}$.

Ordering Part Number	CRI	Warm White CCT	Warm White Typical Flux (lm)	Warm White Min. Flux (lm)	Cool White CCT	Cool White Typical Flux (lm)	Cool White Min. Flux (lm)
CTM-6-6527-90-36-TWD6-F3-3	90	2700K	550	510	6500K	630	585
CTM-9-6527-90-36-TWD6-F3-3			930	865		1,065	990
CTM-14-6527-90-36-TWD6-F3-3			2,700	2,510		3,080	2,865
CTM-18-6527-90-36-TWD6-F3-3			5,080	5,010		5,770	5,700
CTM-22-6527-90-36-TWD6-F3-3			6,010	5,950		6,480	6,760
CTM-6-4018-90-36-TWD6-F3-3	90	1800K	420	390	4000K	660	615
CTM-9-4018-90-36-TWD6-F3-3			690	640		1,120	1,040
CTM-14-4018-90-36-TWD6-F3-3			1,940	1,805		3,315	3,040
CTM-18-4018-90-36-TWD6-F3-3			3,755	3,490		5,600	5,210
CTM-22-4018-90-36-TWD6-F3-3			4,400	4,090		6,440	5,990
CTM-6-5022-90-36-TWD6-F3-3	90	2200K	510	475	5000K	590	550
CTM-9-5022-90-36-TWD6-F3-3			855	795		1,005	935
CTM-14-5022-90-36-TWD6-F3-3			2,375	2,210		2,775	2,580
CTM-18-5022-90-36-TWD6-F3-3			4,160	3,870		4,760	4,425
CTM-22-5022-90-36-TWD6-F3-3			5,040	4,685		5,740	5,340

Operating Characteristics¹

Parameter - CTM-6	Symbol	Minimum	Typical	Maximum	Unit
Forward Current Per Channel ^{1,2}	I_f		150	225	mA
Forward Voltage Per Channel ³	V_f	30.8	33	37	V
Power Per Channel			5	8	W
Light Emitting Surface Diameter	LES		6.8		mm
Thermal Resistance (junction-to-case)	Θ_{jc}		1.14		$^\circ\text{C}/\text{W}$

Parameter - CTM-9	Symbol	Minimum	Typical	Maximum	Unit
Forward Current Per Channel ^{1,2}	I_f		250	450	mA
Forward Voltage Per Channel ³	V_f	30.8	33	37	V
Power Per Channel			8	22	W
Light Emitting Surface Diameter	LES		9.2		mm
Thermal Resistance (junction-to-case)	Θ_{jc}		0.52		$^\circ\text{C}/\text{W}$



Operating Characteristics (con.)¹

Parameter - CTM-14	Symbol	Minimum	Typical	Maximum	Unit
Forward Current Per Channel ^{1,2}	I_f		700	900	mA
Forward Voltage Per Channel ³	V_f	30.8	33	37	V
Power Per Channel			24	30	W
Light Emitting Surface Diameter	LES		13.9		mm
Thermal Resistance (junction-to-case)	Θ_{jc}		0.41		°C/W

Parameter - CTM-18	Symbol	Minimum	Typical	Maximum	Unit
Forward Current Per Channel ^{1,2}	I_f		1200	1500	mA
Forward Voltage Per Channel ³	V_f	30.8	33	37	V
Power Per Channel			30	52	W
Light Emitting Surface Diameter	LES		19.6		mm
Thermal Resistance (junction-to-case)	Θ_{jc}		0.27		°C/W

Parameter - CTM-22	Symbol	Minimum	Typical	Maximum	Unit
Forward Current Per Channel ^{1,2}	I_f		1400	1700	mA
Forward Voltage Per Channel ³	V_f	30.8	34	37	V
Power Per Channel			36	59	W
Light Emitting Surface Diameter	LES		23.5		mm
Thermal Resistance (junction-to-case)	Θ_{jc}		0.27		°C/W

Parameter	Symbol	Minimum	Typical	Maximum	Unit
Operating Case Temperature	T_c			105	°C
Junction Temperature	T_j			140	°C
Viewing Angle			120		Degree

Notes:

1. Device measurements are at $T_j = 85^\circ\text{C}$.
2. To prevent damage refer to operating conditions and derating curves for appropriate maximum operating conditions
3. Voltage is rated at typical forward current. For voltage at higher drive current, refer to performance graphs.
4. Thermal resistance is measured from LED junction-to- T_c (thermal contact point), at typical current using JESD51-14.
5. Device operation not recommended at drive currents less than 10% of the typical value
6. Caution must be taken not to stare at the light emitted from these LEDs. Under special circumstances, the high intensity could damage the eye.

Note: Luminus maintains a +/- 6% tolerance on flux measurements.

Luminus maintains a +/- 2% tolerance on CRI measurements.

Luminus maintains a +/- 0.005 tolerance on chromaticity (CIEx and CIEy) measurements



Typical optical/Electrical Characteristics Graphs

CTM-6-6527-90-36-TWD6-F3-3

Forward Current vs. Flux($T_j = 85^\circ\text{C}$)

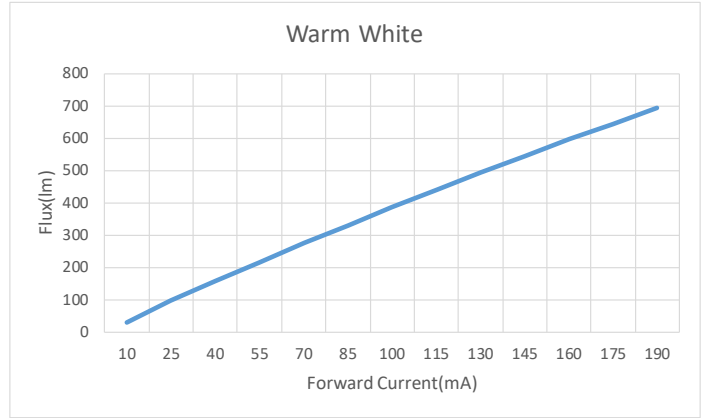

Forward Current vs. Forward Voltage @ $T_j=85$

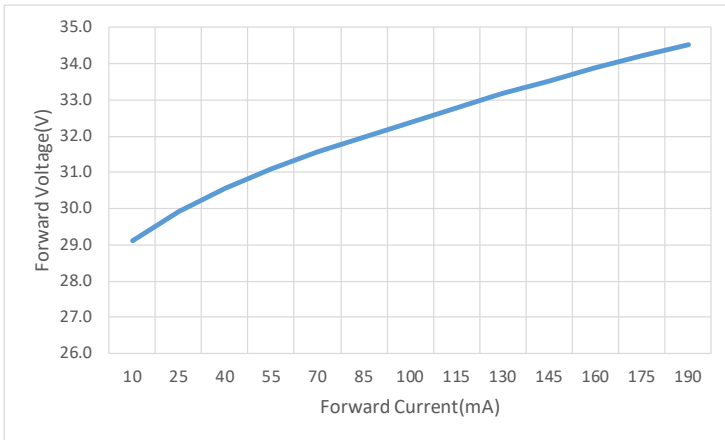

Typical V_f @ Nominal I_f vs. Junction Temperature

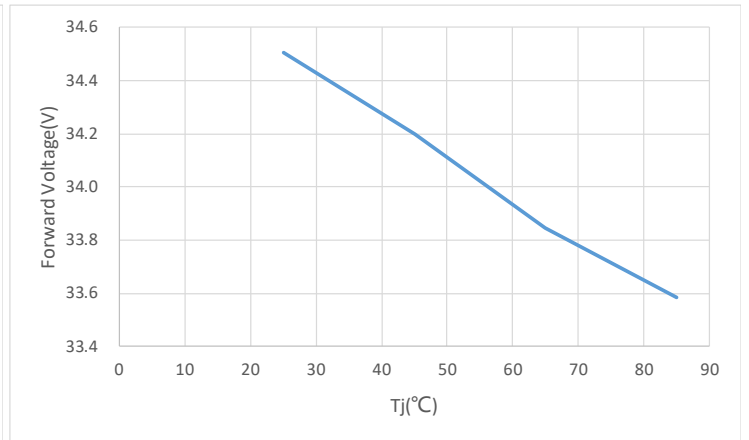

Relative Flux@Nominal I_f vs. Junction Temperature

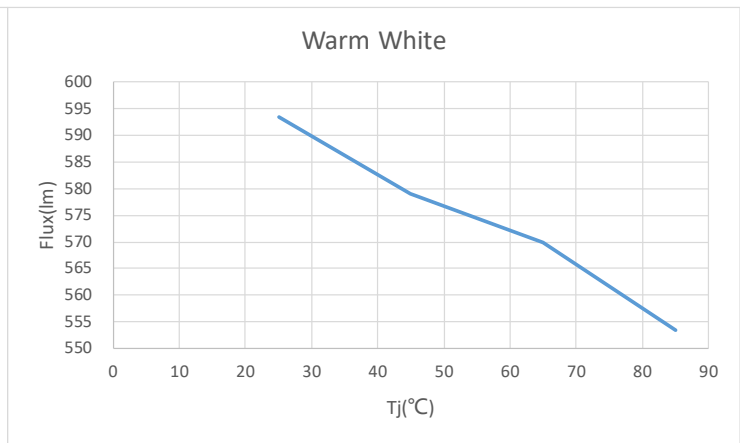
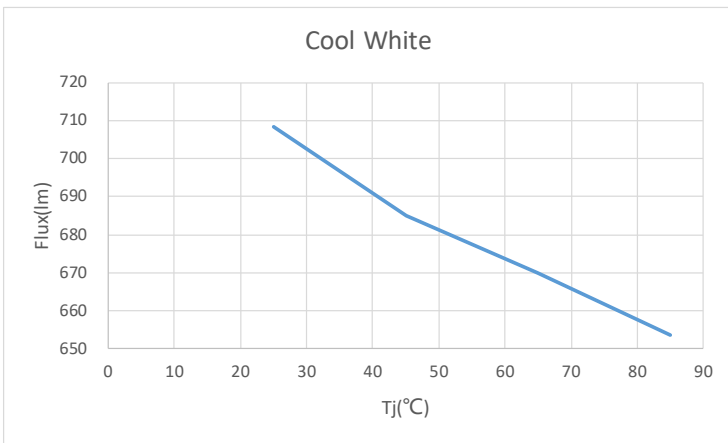



Typical optical/Electrical Characteristics Graphs

CTM-9-6527-90-36-TWD6-F3-3

Forward Current vs. Flux($T_j = 85^\circ\text{C}$)

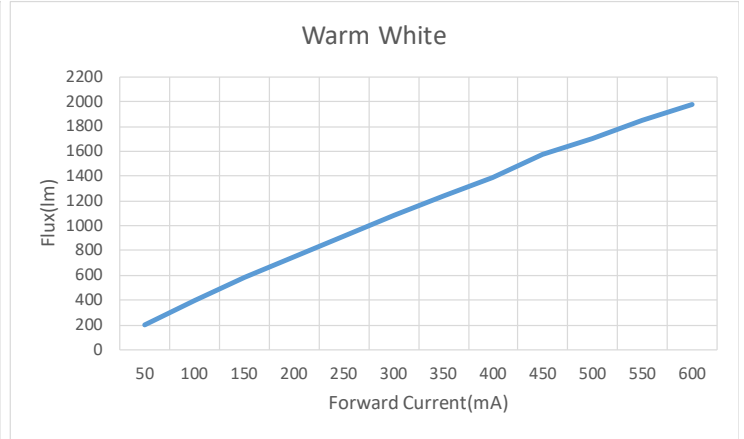

Forward Current vs. Forward Voltage @ $T_j=85$

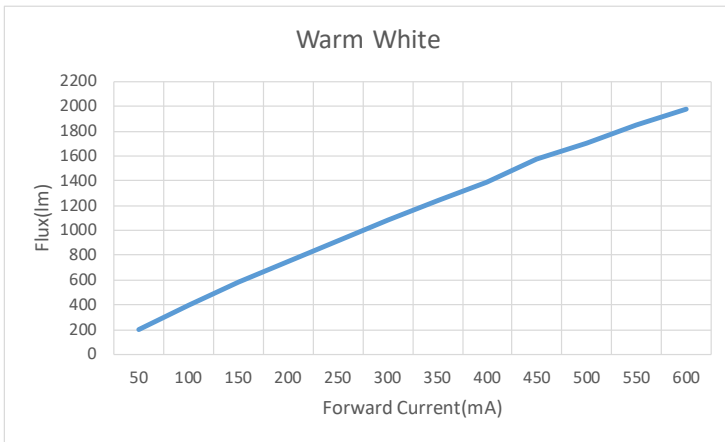

Typical V_f @Nominal I_f vs. Junction Temperature

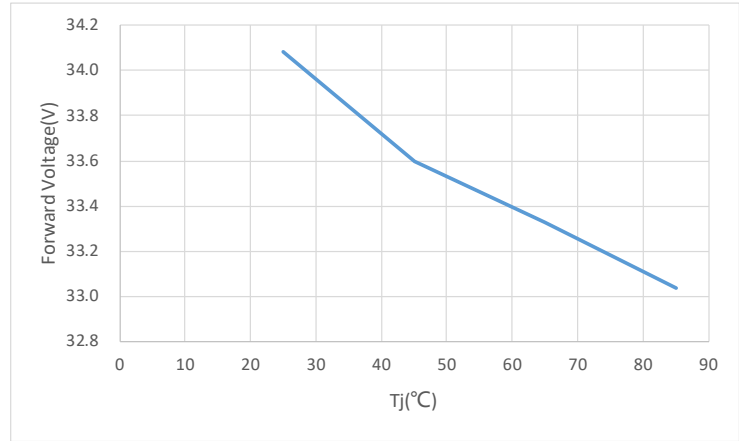

Relative Flux @Nominal I_f vs. Junction Temperature

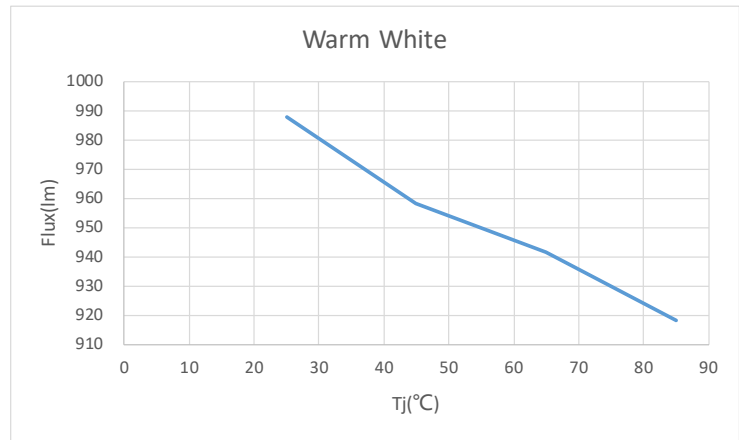
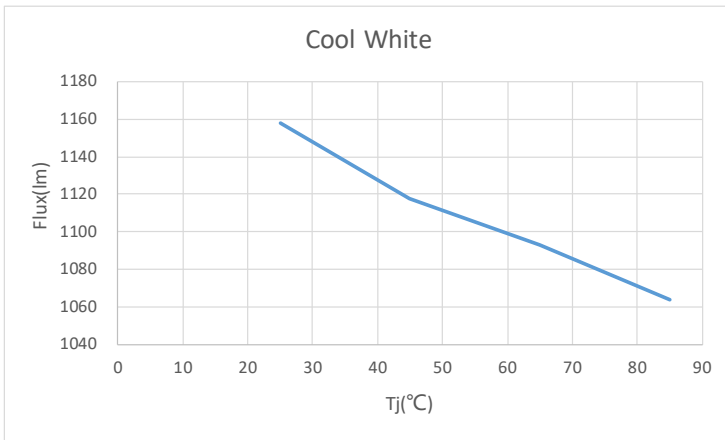



Typical optical/Electrical Characteristics Graphs

CTM-14-6527-90-36-TWD6-F3-3

Forward Current vs. Flux(T_j = 85°C)

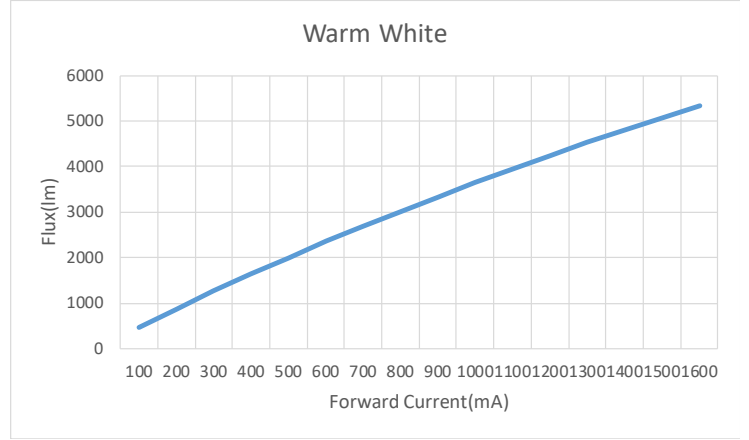
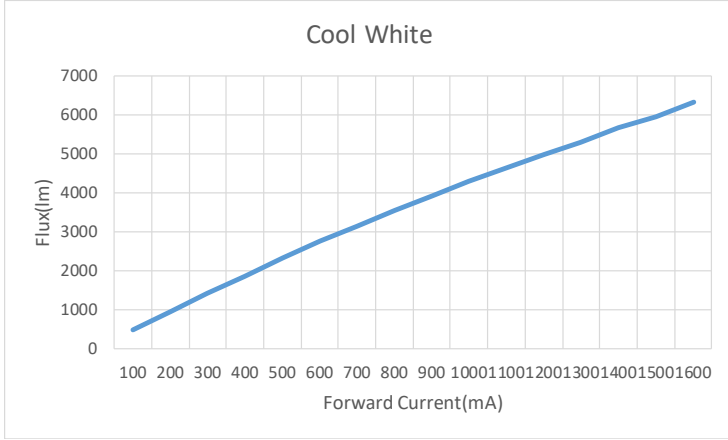

Forward Current vs. Forward Voltage @T_j=85

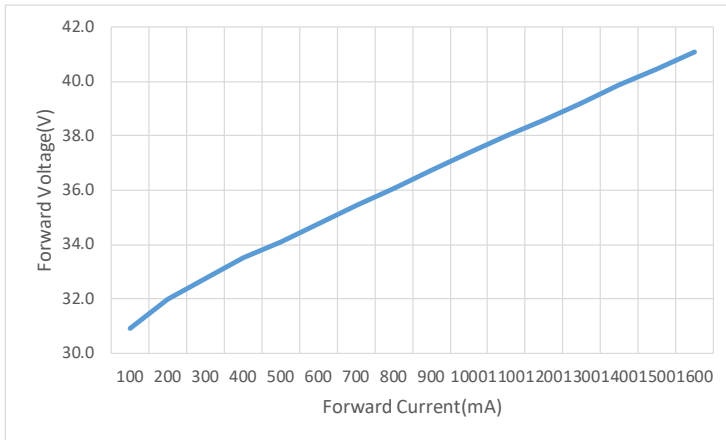

Typical Vf @Nominal If vs. Junction Temperature

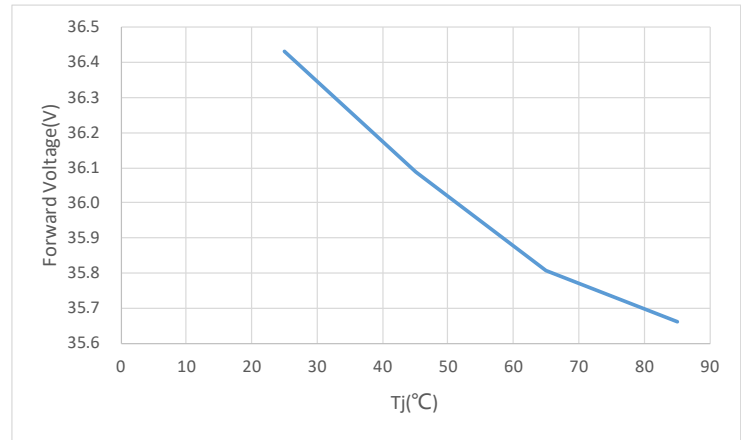

Relative Flux @Nominal If vs. Junction Temperature

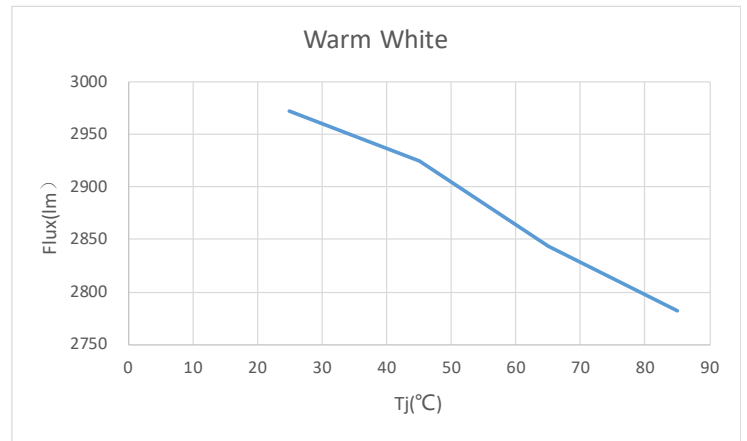
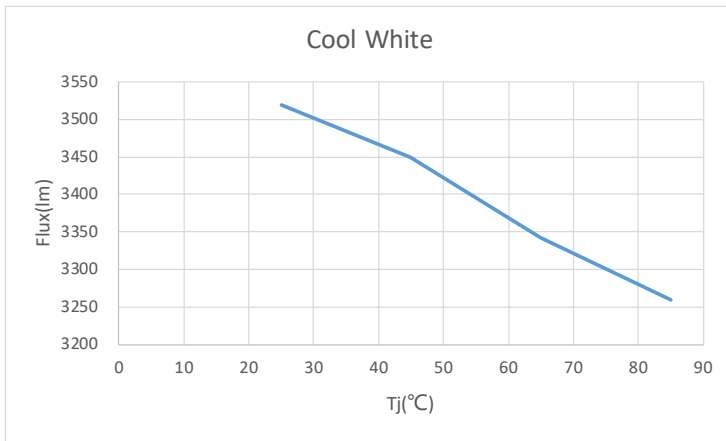



Typical optical/Electrical Characteristics Graphs

CTM-18-6527-90-36-TWD6-F3-3

Forward Current vs. Flux($T_j = 85^\circ\text{C}$)

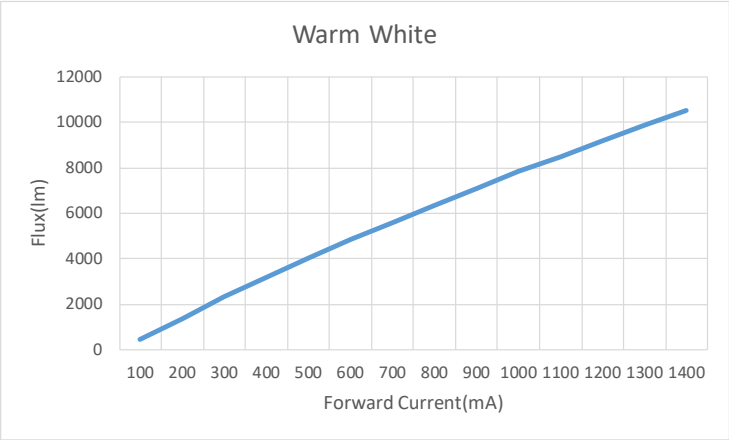
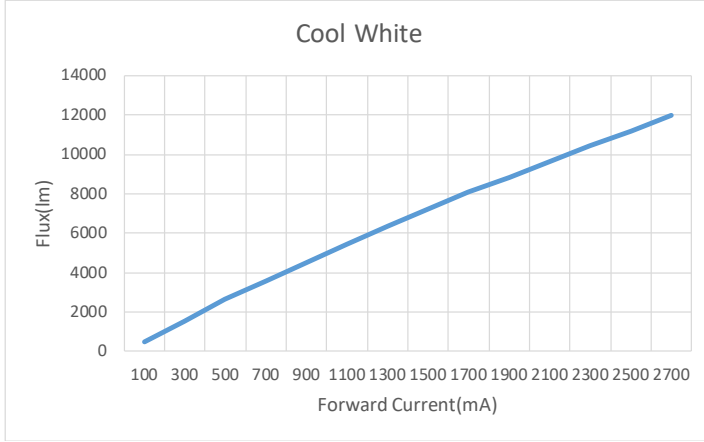

Forward Current vs. Forward Voltage @ $T_j=85$

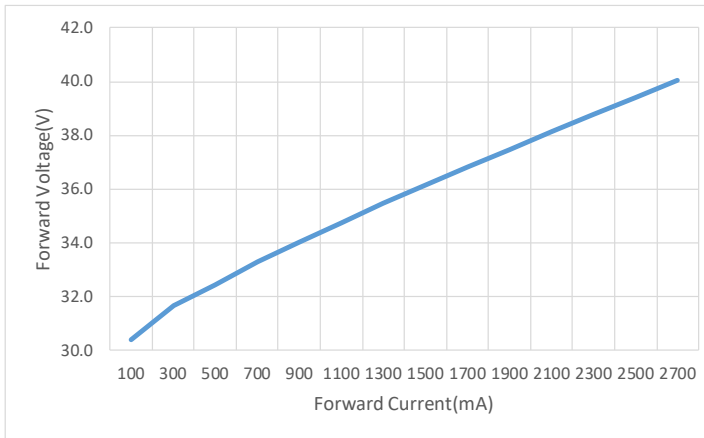

Typical V_f @Nominal I_f vs. Junction Temperature

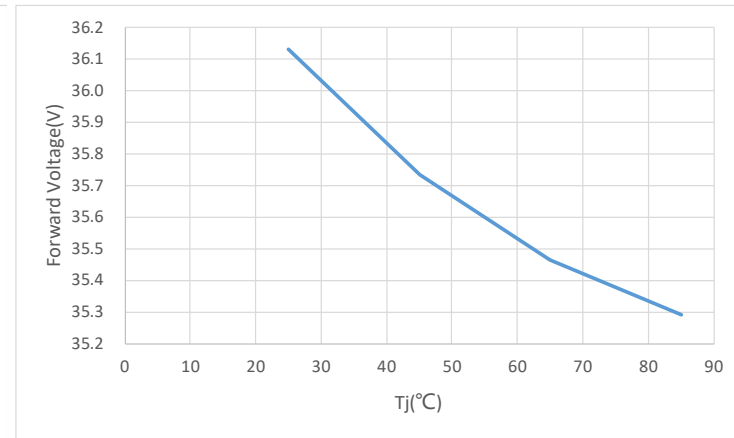

Relative Flux @Nominal I_f vs. Junction Temperature

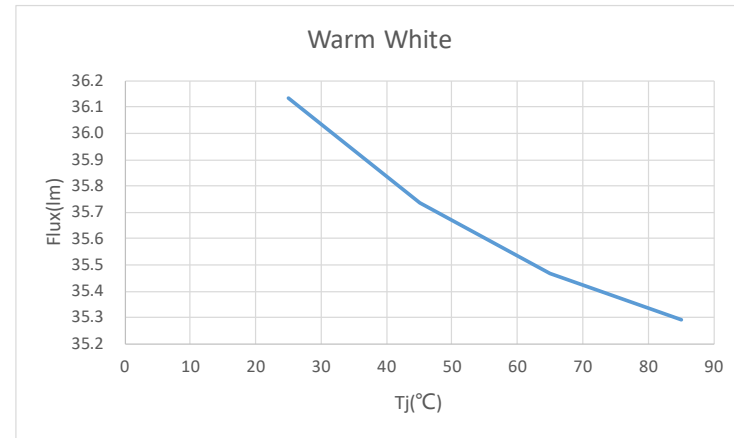
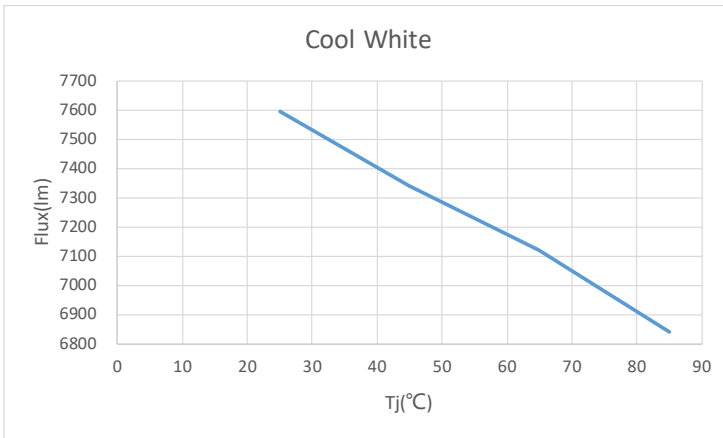



Typical optical/Electrical Characteristics Graphs

CTM-22-6527-90-36-TWD6-F3-3

Forward Current vs. Flux($T_j = 85^\circ\text{C}$)

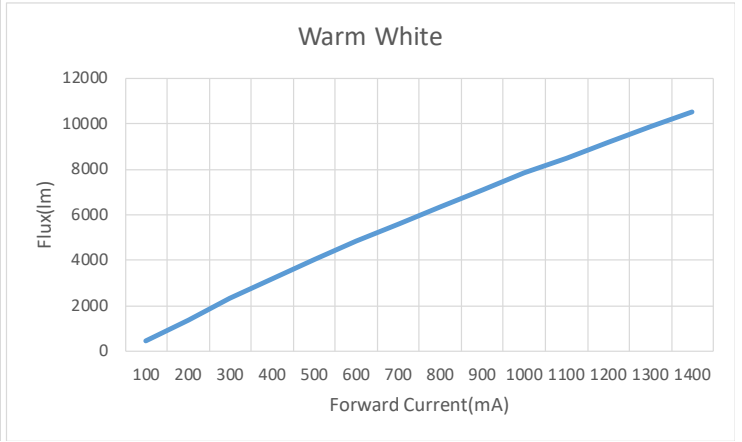
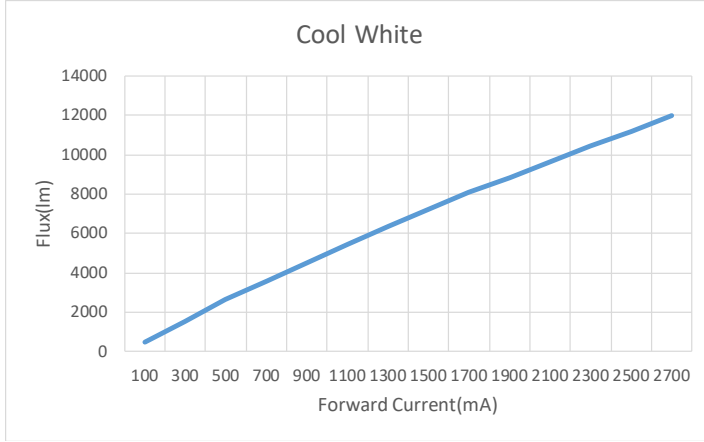

Forward Current vs. Forward Voltage @ $T_j=85$

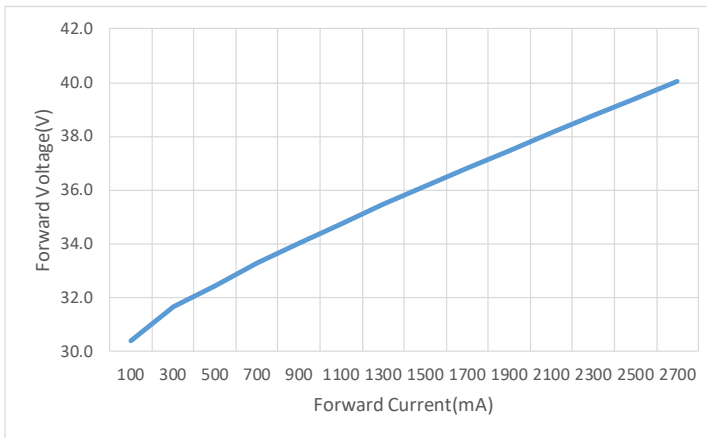

Typical V_f @Nominal I_f vs. Junction Temperature

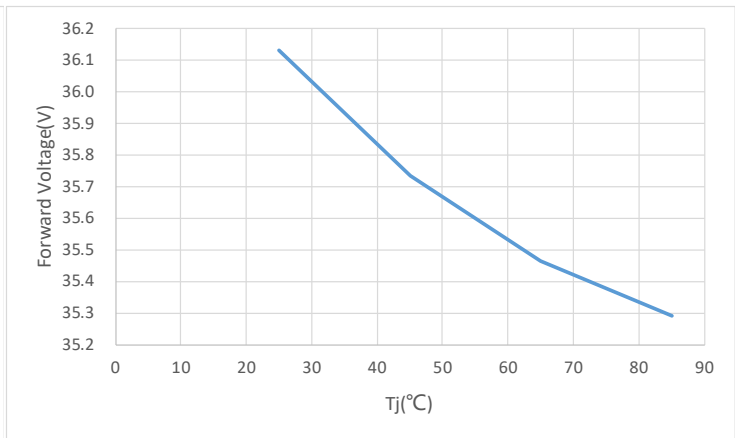

Relative Flux @Nominal I_f vs. Junction Temperature

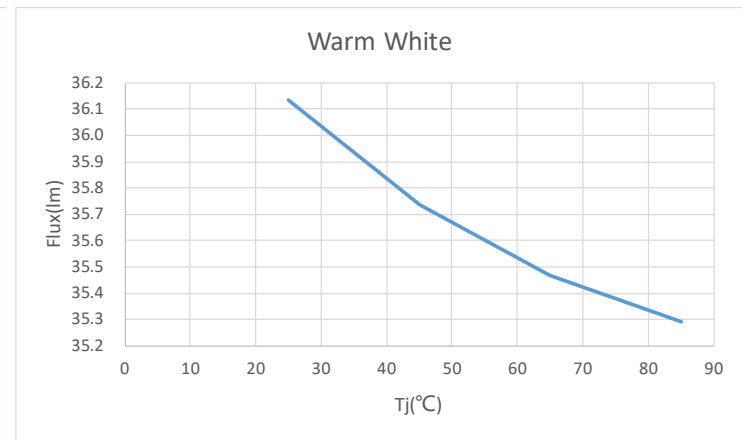
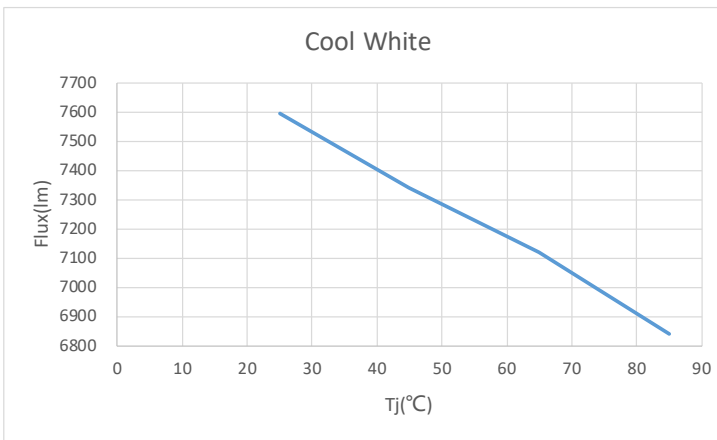



Typical optical/Electrical Characteristics Graphs

CTM-6-4018-90-36-TWD6-F3-3

Forward Current vs. Flux(T_j = 85°C)

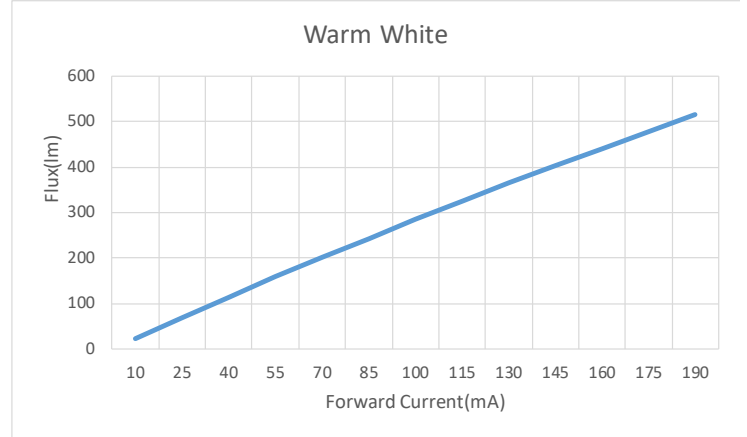

Forward Current vs. Forward Voltage @T_j=85

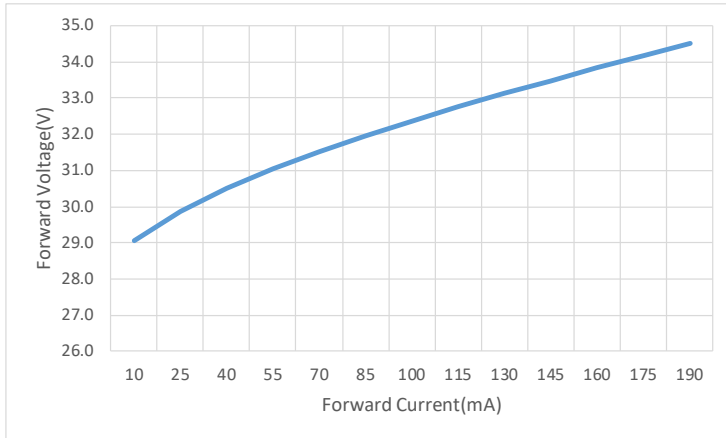

Typical Vf @Nominal If vs. Junction Temperature

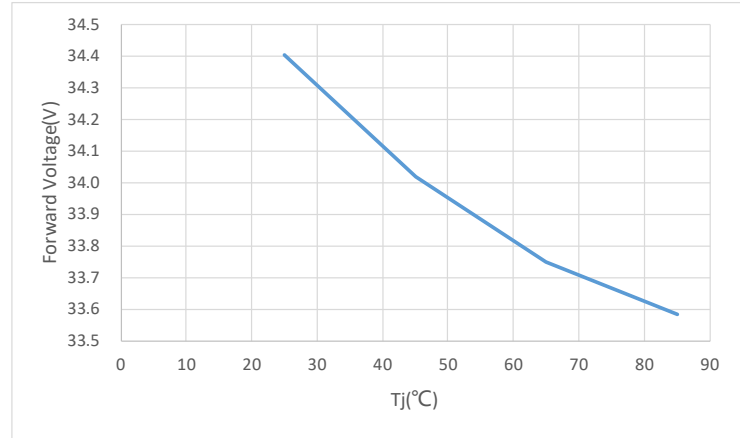

Relative Flux @Nominal If vs. Junction Temperature

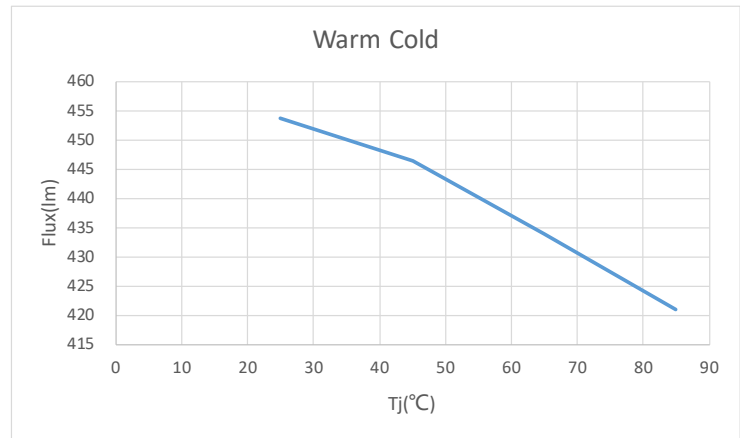
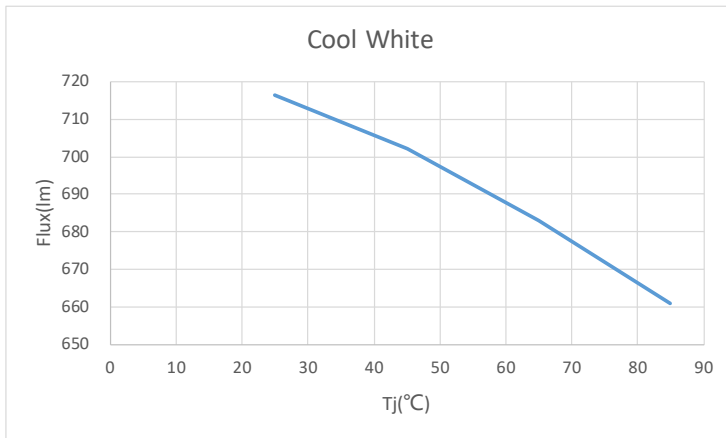



Typical optical/Electrical Characteristics Graphs

CTM-9-4018-90-36-TWD6-F3-3

Forward Current vs. Flux(Tj = 85°C)

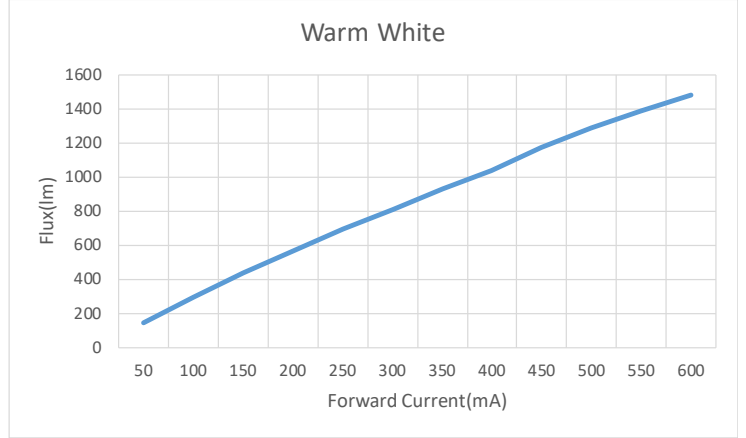

Forward Current vs. Forward Voltage @Tj=85

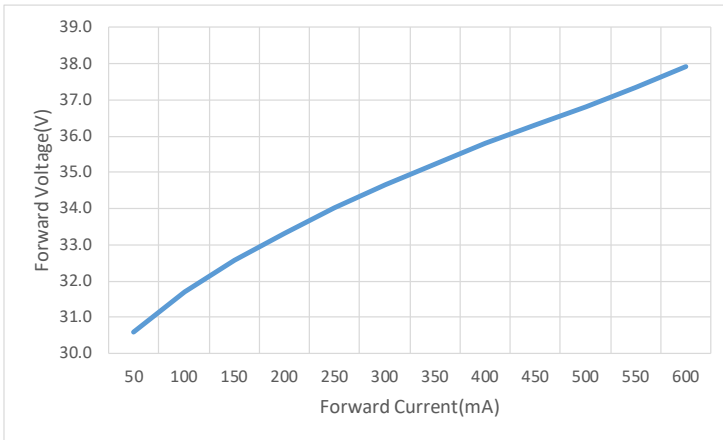

Typical Vf @Nominal If vs. Junction Temperature

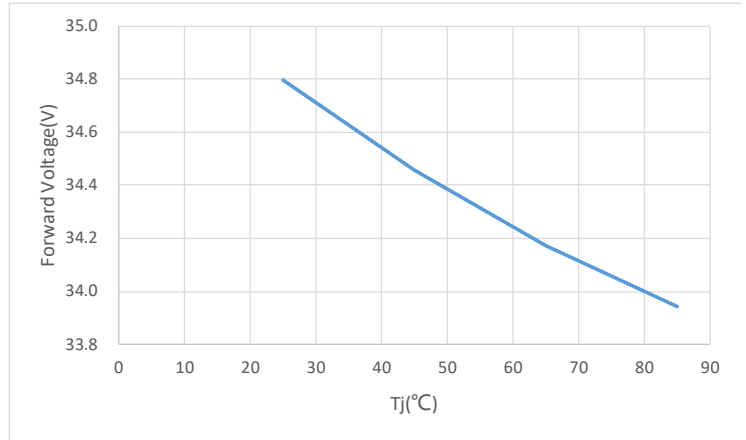

Relative Flux @Nominal If vs. Junction Temperature

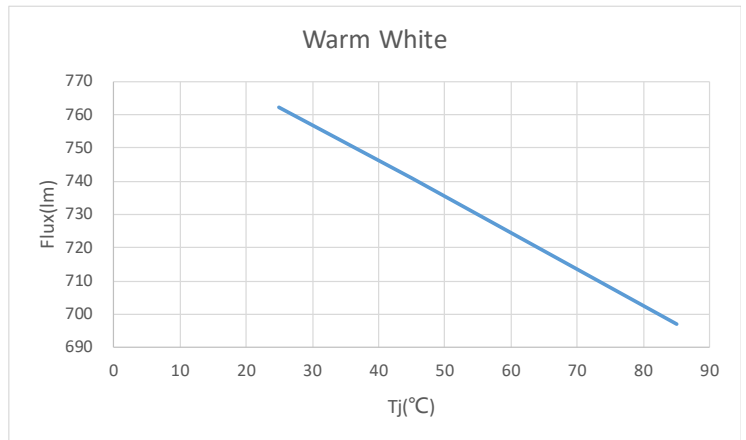
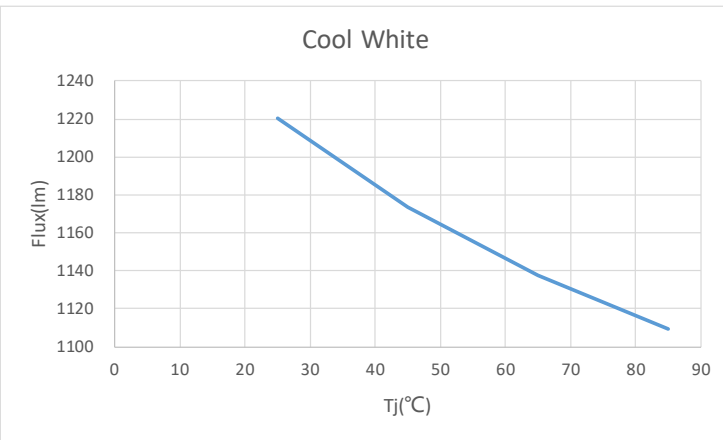



Typical optical/Electrical Characteristics Graphs

CTM-14-4018-90-36-TWD6-F3-3

Forward Current vs. Flux($T_j = 85^\circ\text{C}$)

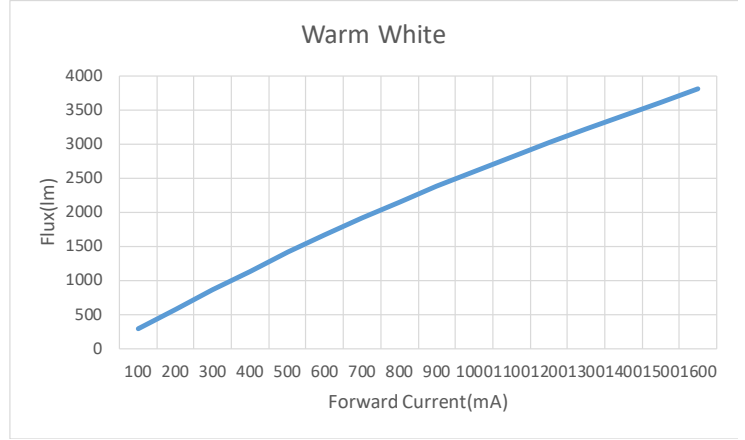
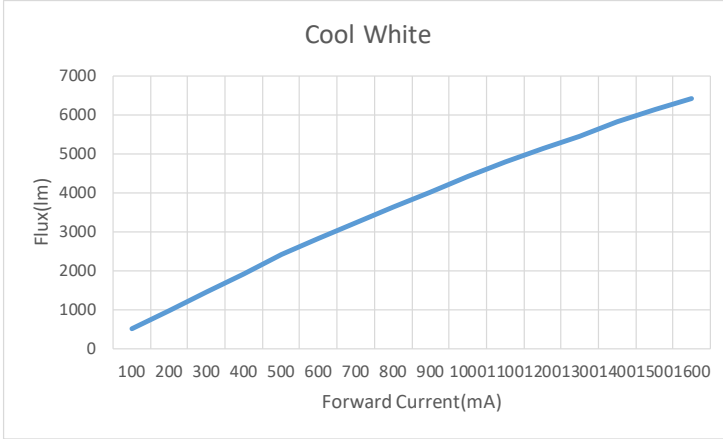

Forward Current vs. Forward Voltage @ $T_j=85$

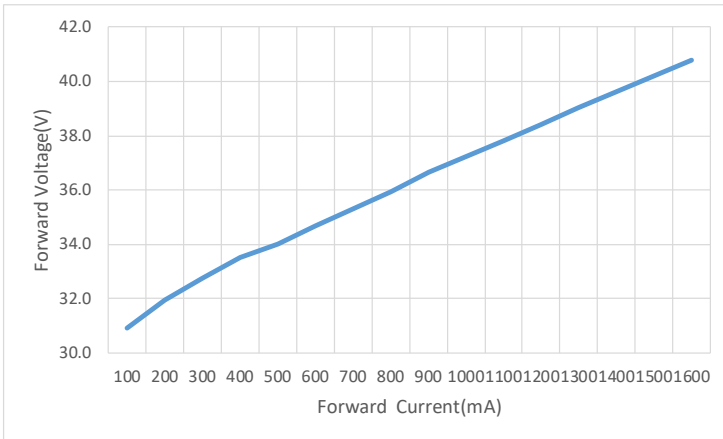

Typical V_f @Nominal I_f vs. Junction Temperature

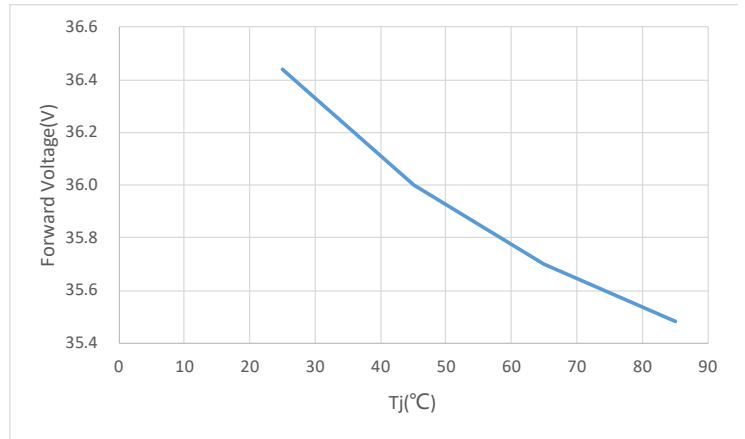

Relative Flux @Nominal I_f vs. Junction Temperature

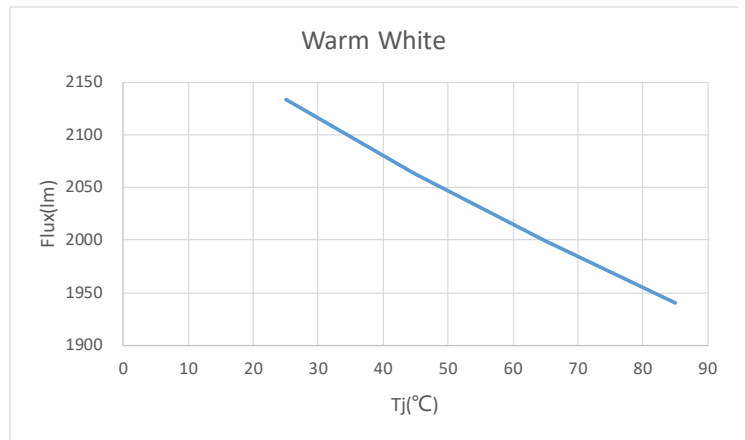
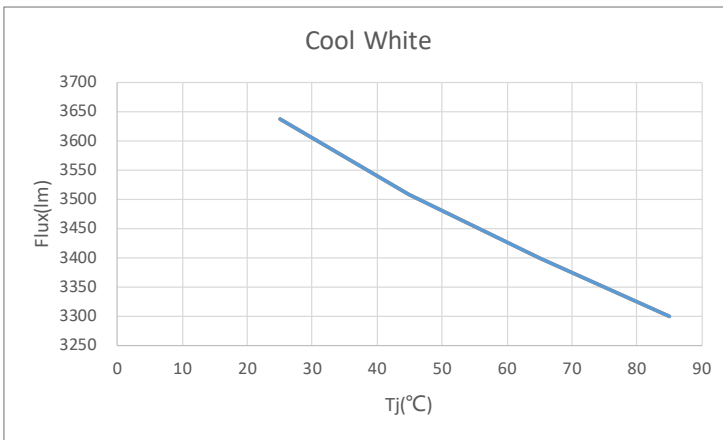



Typical optical/Electrical Characteristics Graphs

CTM-18-4018-90-36-TWD6-F3-3

Forward Current vs. Flux(Tj = 85°C)

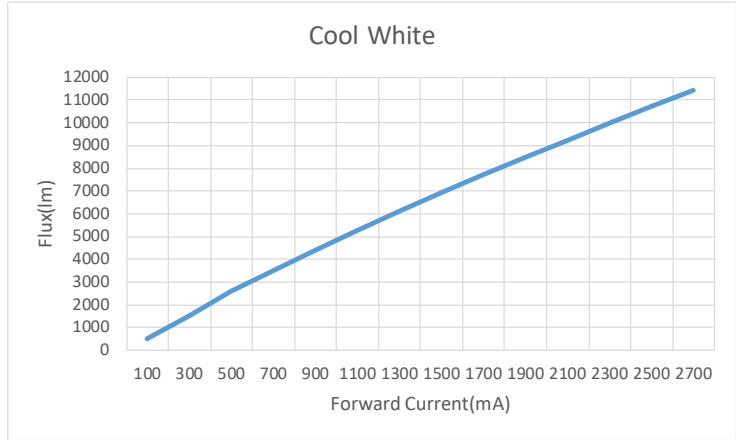
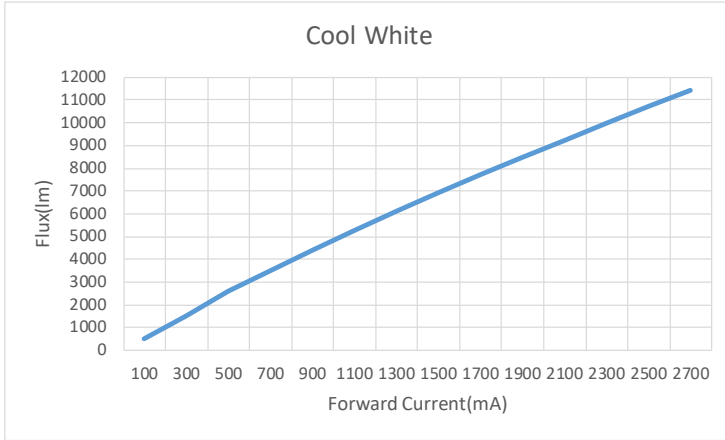

Forward Current vs. Forward Voltage @Tj=85

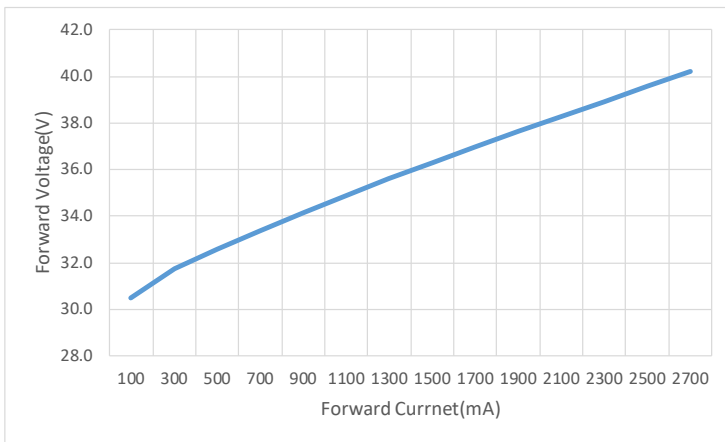

Typical Vf @Nominal If vs. Junction Temperature

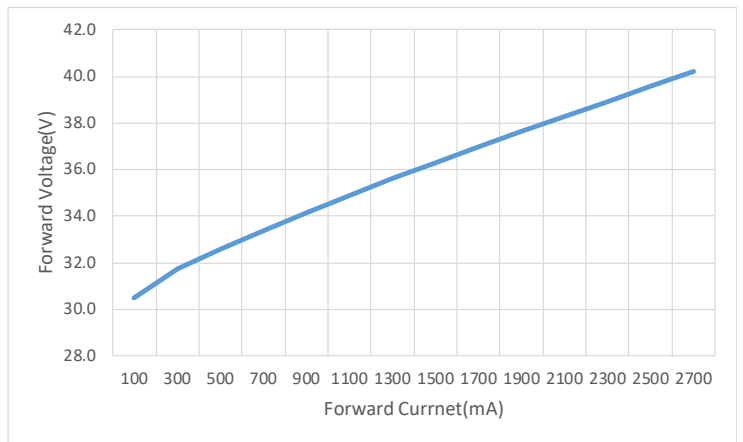

Relative Flux @Nominal If vs. Junction Temperature

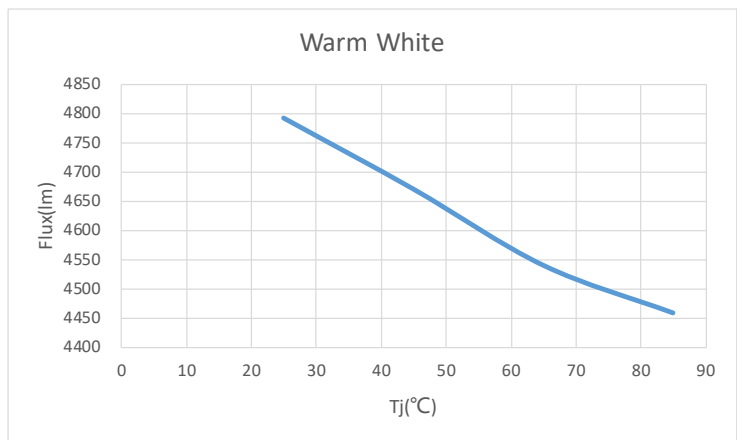
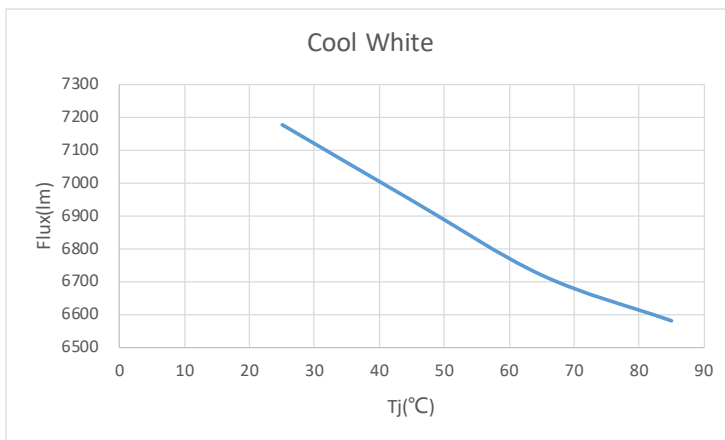



Typical optical/Electrical Characteristics Graphs

CTM-22-4018-90-36-TWD6-F3-3

Forward Current vs. Flux($T_j = 85^\circ\text{C}$)

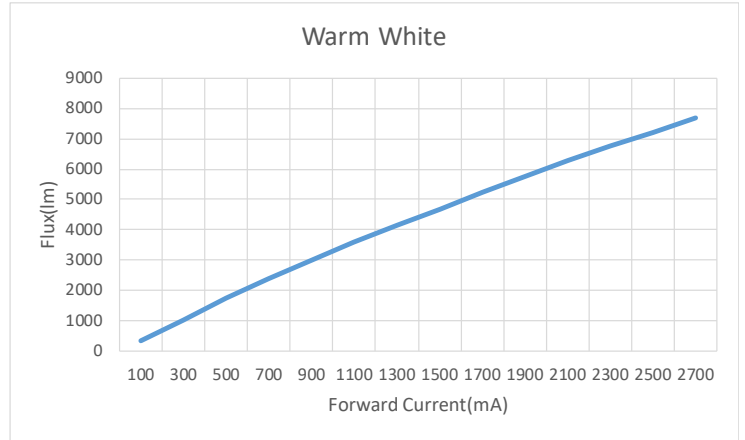
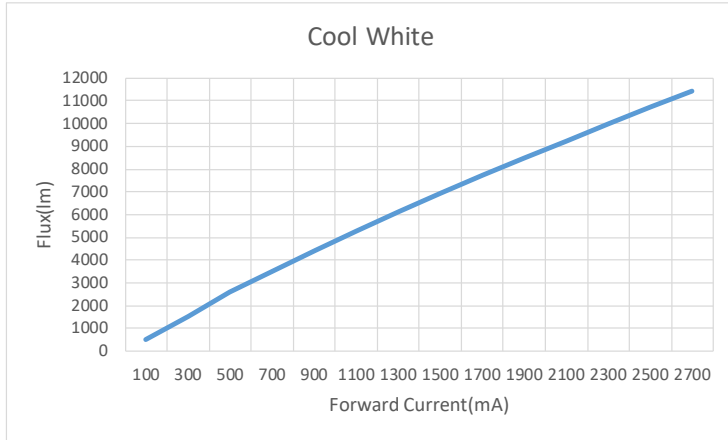

Forward Current vs. Forward Voltage @ $T_j=85$

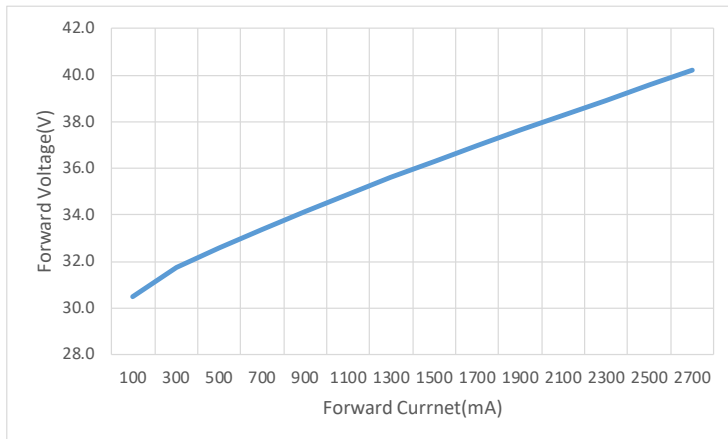

Typical V_f @ Nominal I_f vs. Junction Temperature

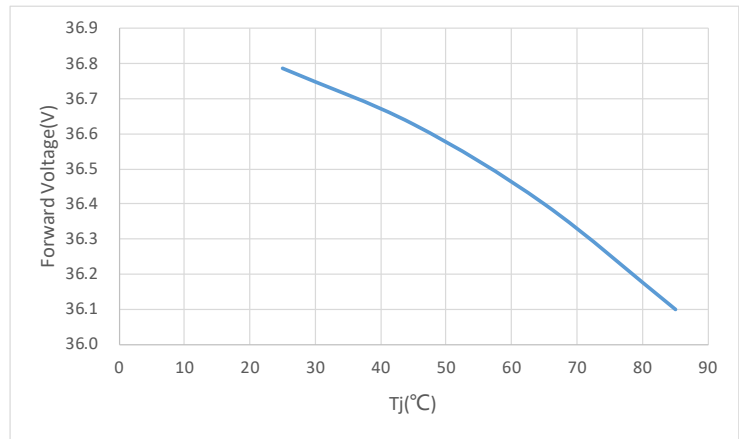

Relative Flux @ Nominal I_f vs. Junction Temperature

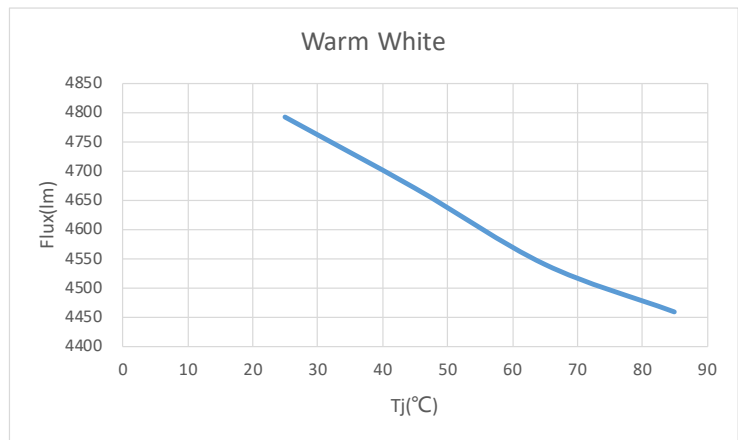
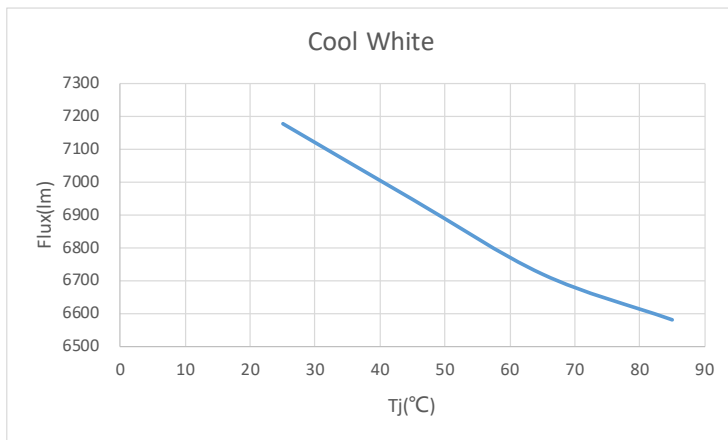



Typical optical/Electrical Characteristics Graphs

CTM-6-5022-90-36-TWD6-F3-3

Forward Current vs. Flux($T_j = 85^\circ\text{C}$)

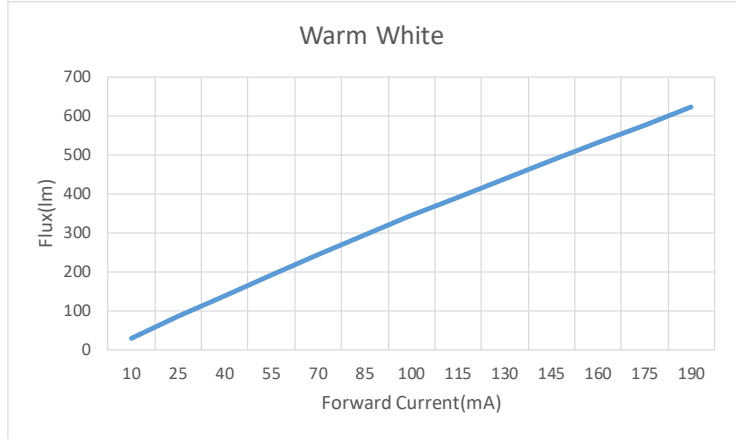

Forward Current vs. Forward Voltage @ $T_j=85$

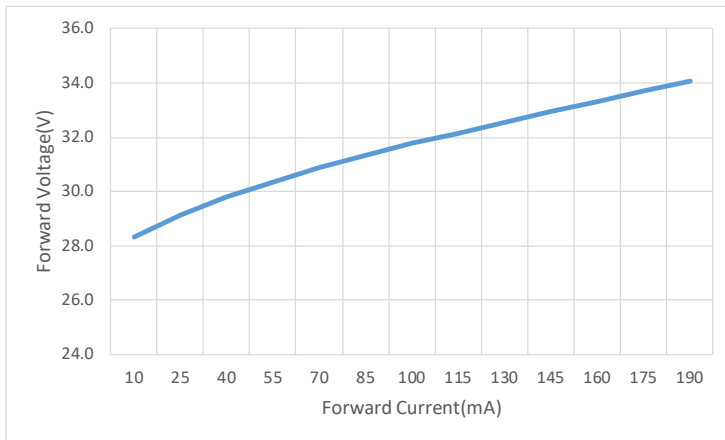

Typical V_f @ Nominal I_f vs. Junction Temperature

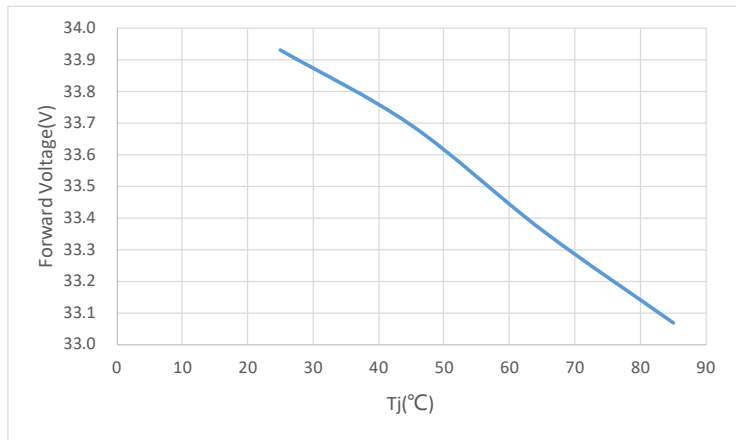

Relative Flux @ Nominal I_f vs. Junction Temperature

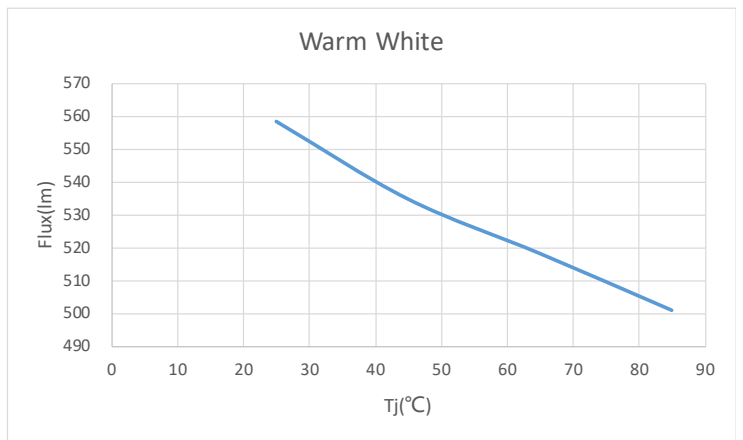
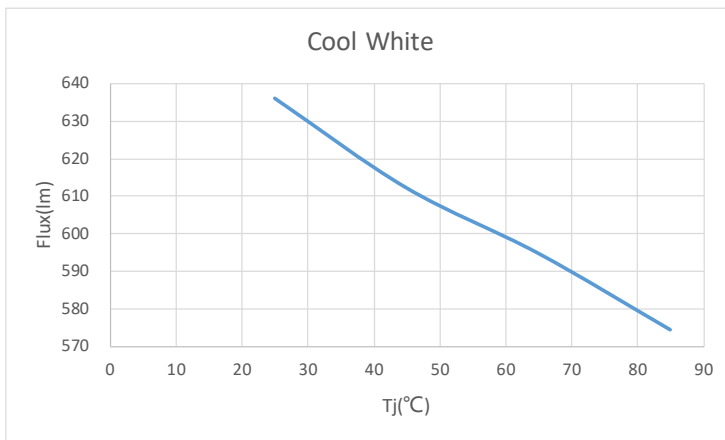



Typical optical/Electrical Characteristics Graphs

CTM-9-5022-90-36-TWD6-F3-3

Forward Current vs. Flux($T_j = 85^\circ\text{C}$)

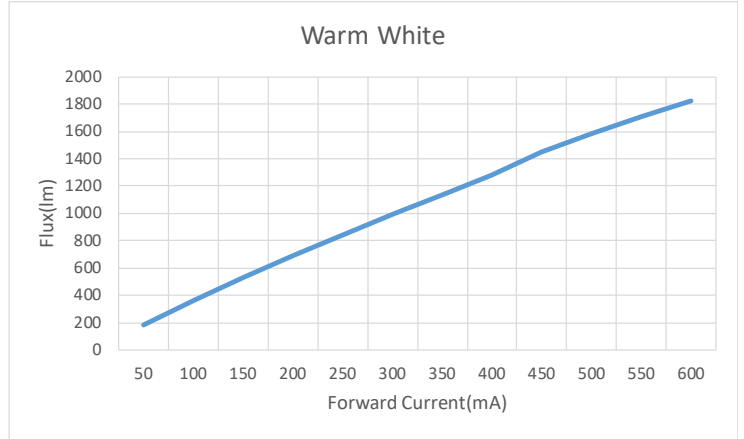
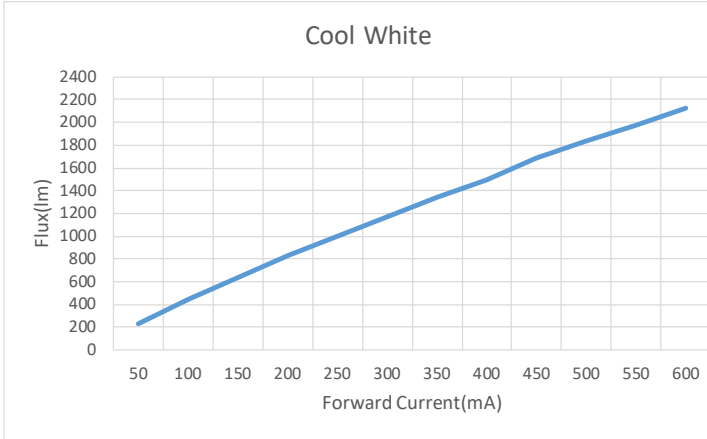

Forward Current vs. Forward Voltage @ $T_j=85$

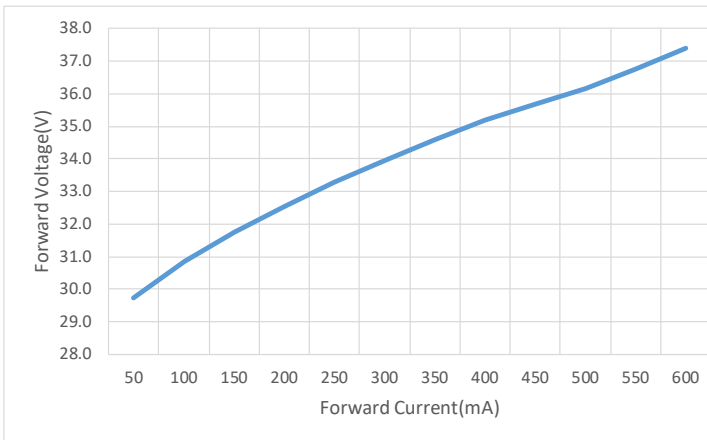

Typical V_f @ Nominal I_f vs. Junction Temperature

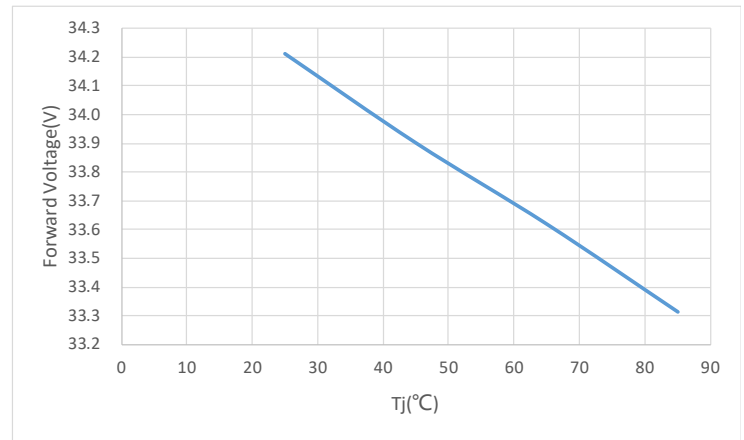

Relative Flux @ Nominal I_f vs. Junction Temperature

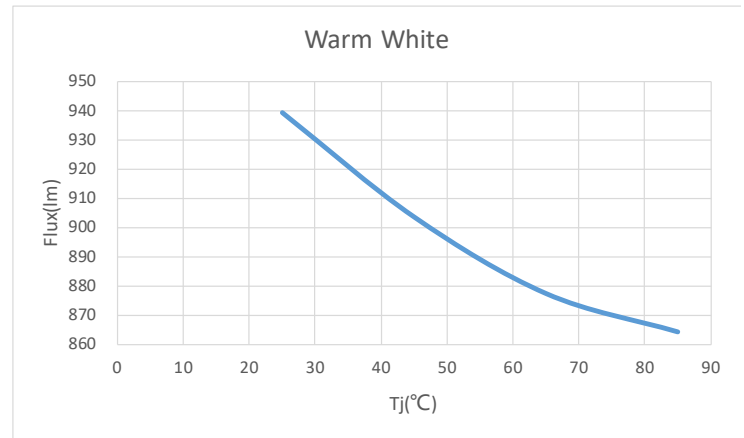
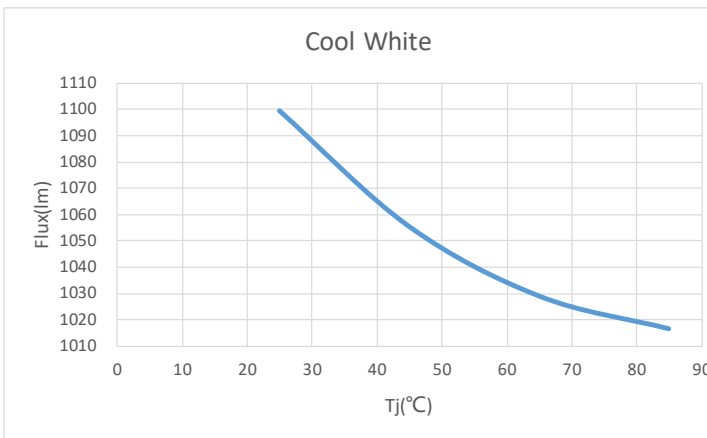



Typical optical/Electrical Characteristics Graphs

CTM-14-5022-90-36-TWD6-F3-3

Forward Current vs. Flux(Tj = 85°C)

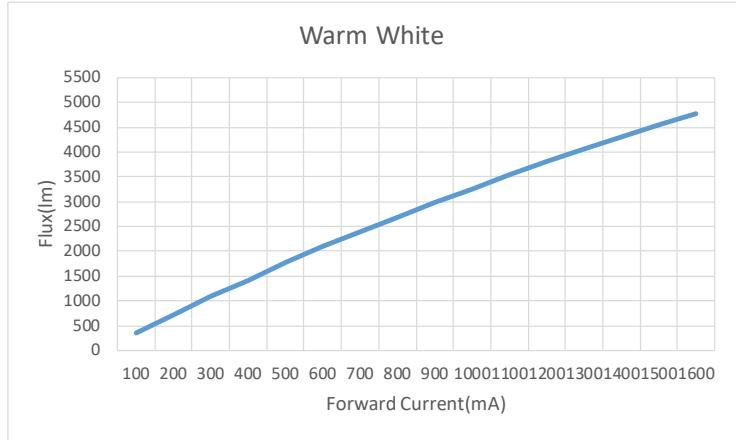
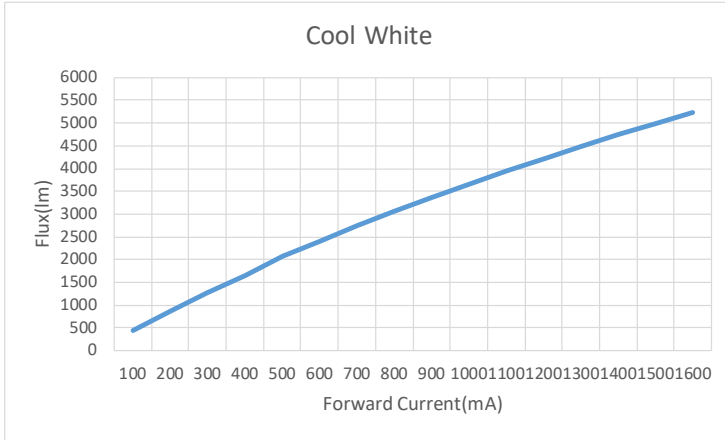

Forward Current vs. Forward Voltage @Tj=85

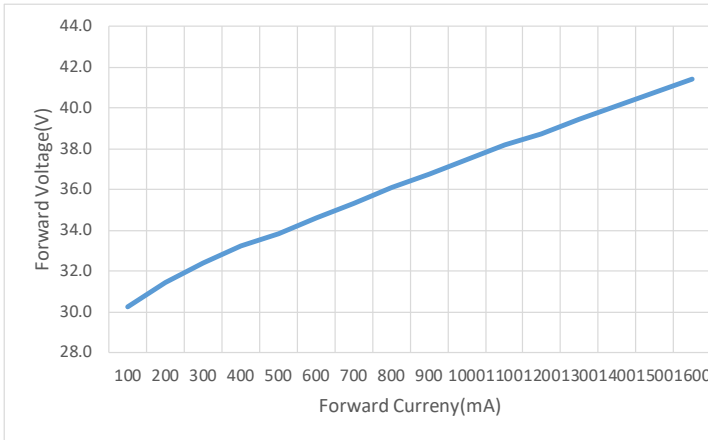

Typical Vf @Nominal If vs. Junction Temperature

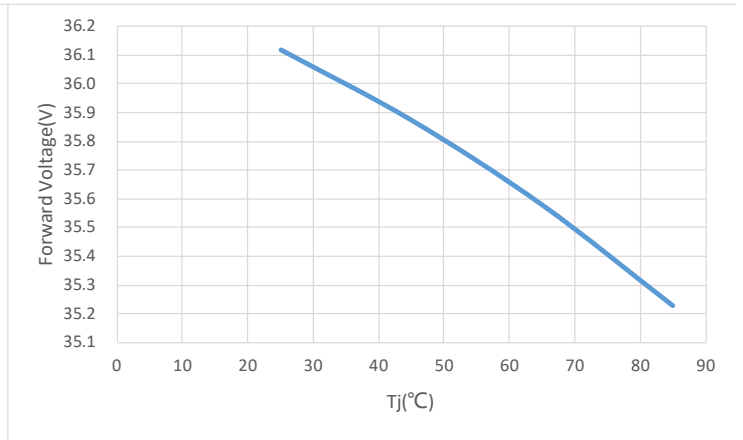

Relative Flux @Nominal If vs. Junction Temperature

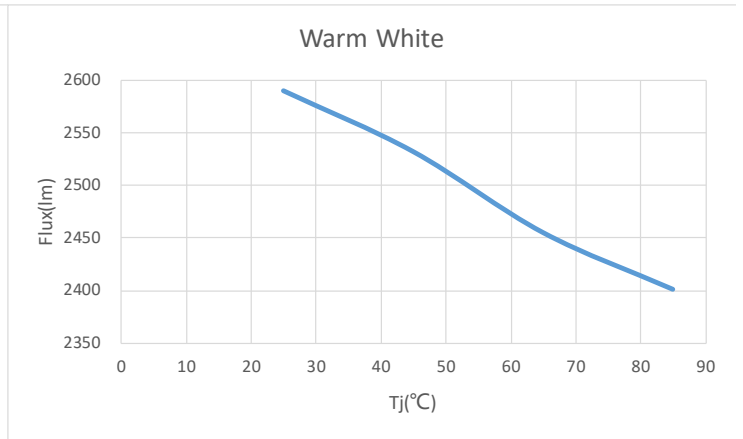
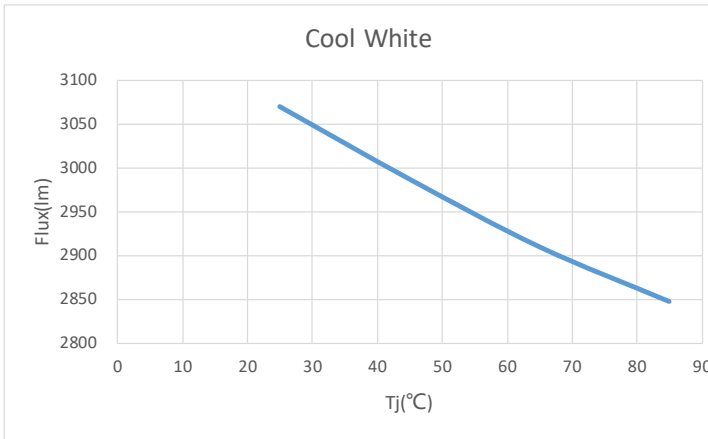



Typical optical/Electrical Characteristics Graphs

CTM-18-5022-90-36-TWD6-F3-3

Forward Current vs. Flux(Tj = 85°C)

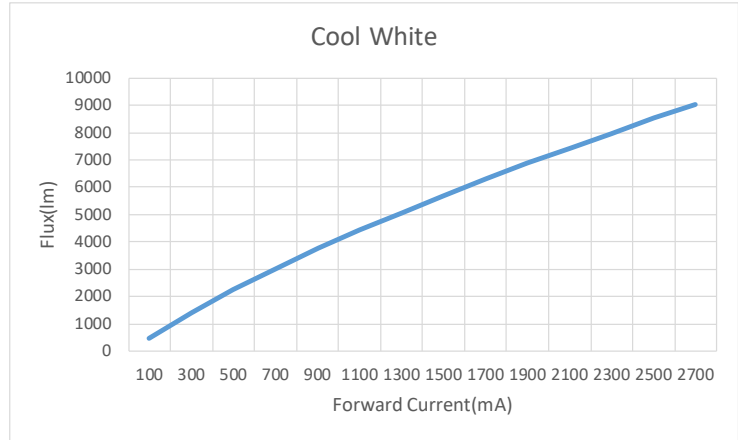
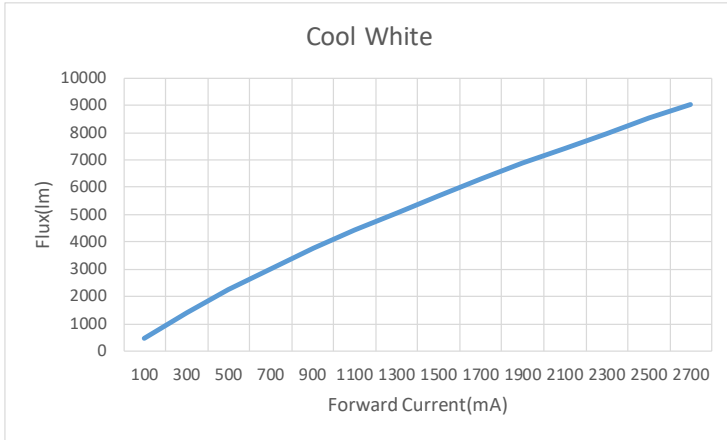

Forward Current vs. Forward Voltage @Tj=85

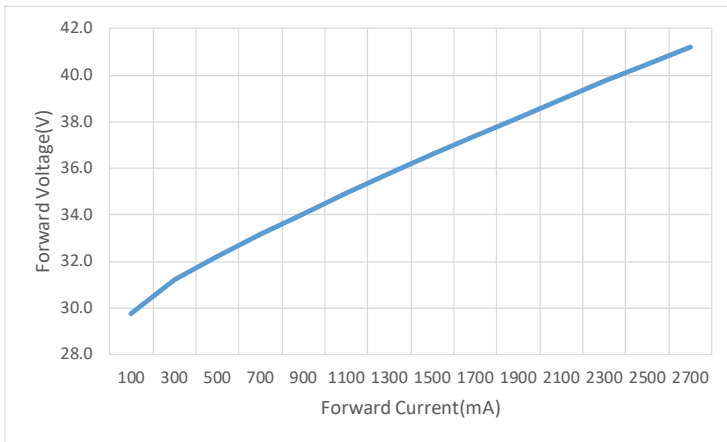

Typical Vf @Nominal If vs. Junction Temperature

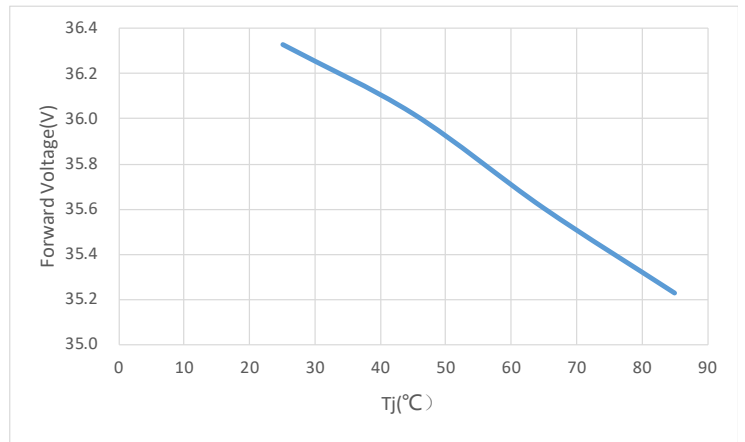

Relative Flux @Nominal If vs. Junction Temperature

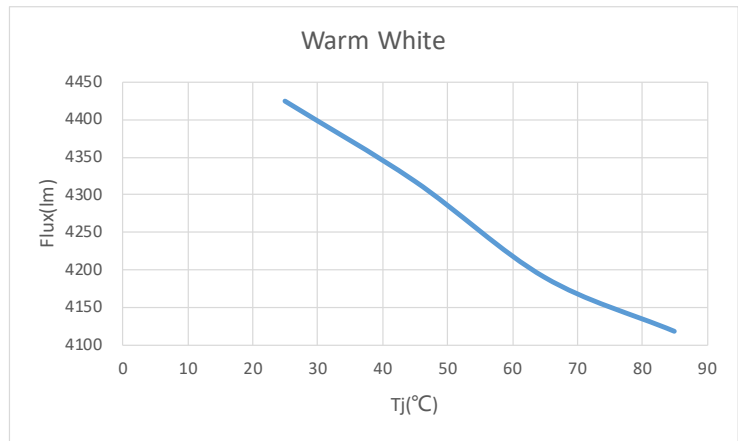
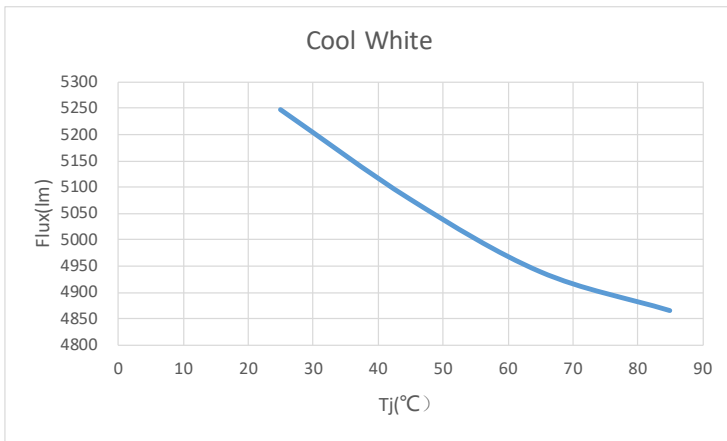



Typical optical/Electrical Characteristics Graphs

CTM-22-5022-90-36-TWD6-F3-3

Forward Current vs. Flux(Tj = 85°C)

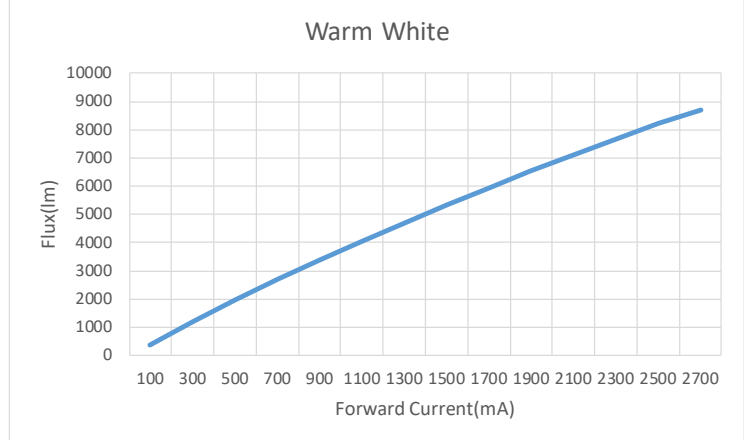
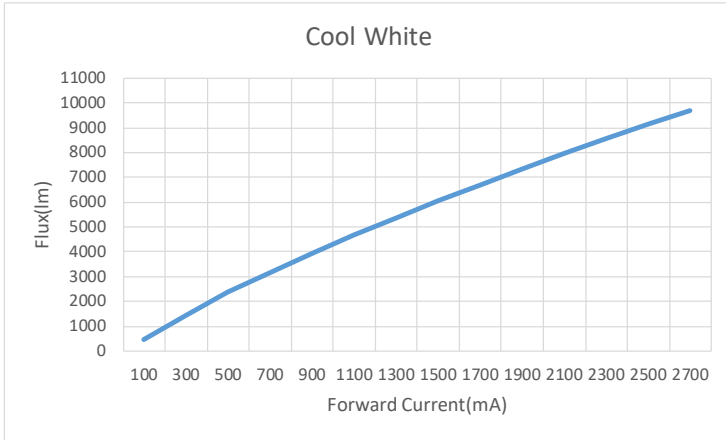

Forward Current vs. Forward Voltage @Tj=85

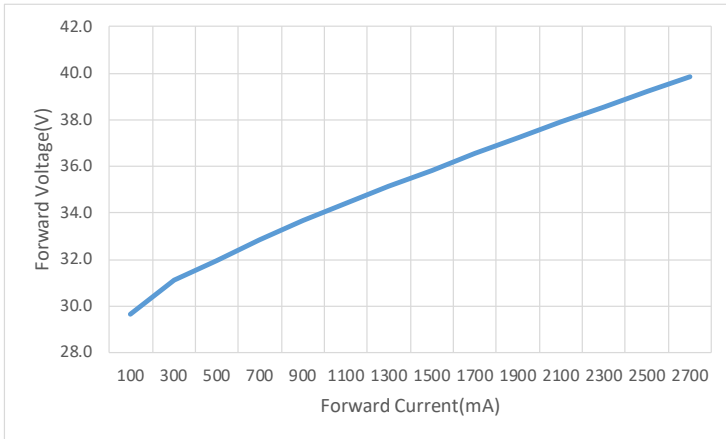

Typical Vf @Nominal If vs. Junction Temperature

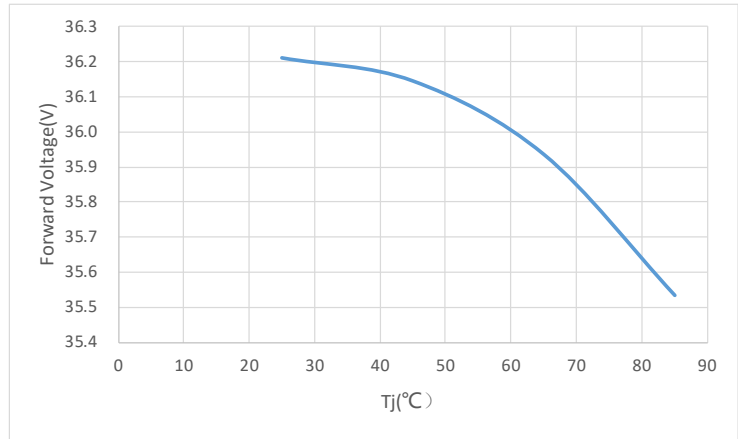

Relative Flux @Nominal If vs. Junction Temperature

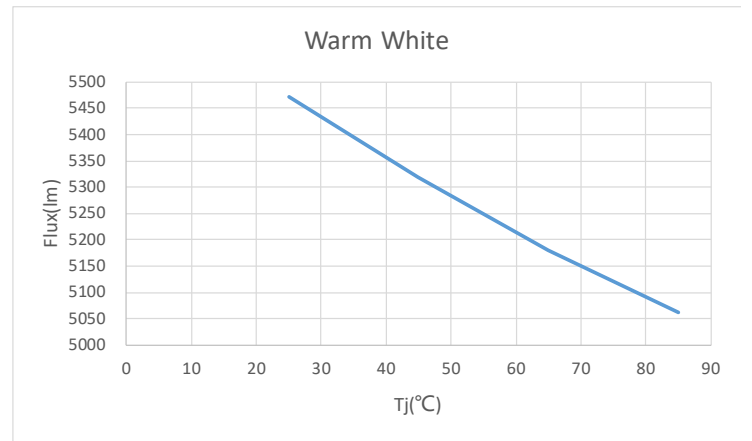
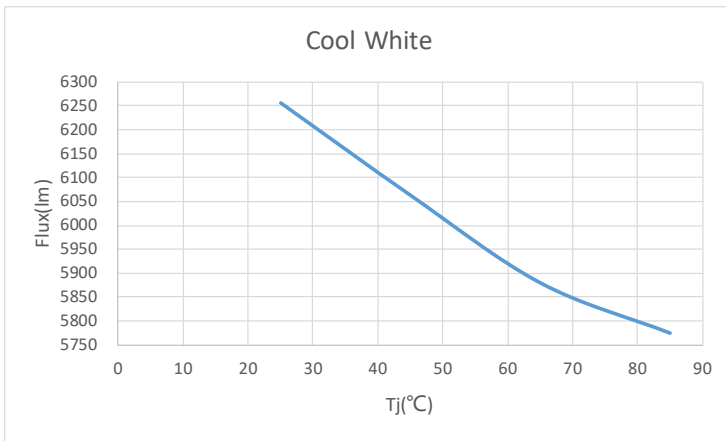



Typical Spectrum

6527 Series

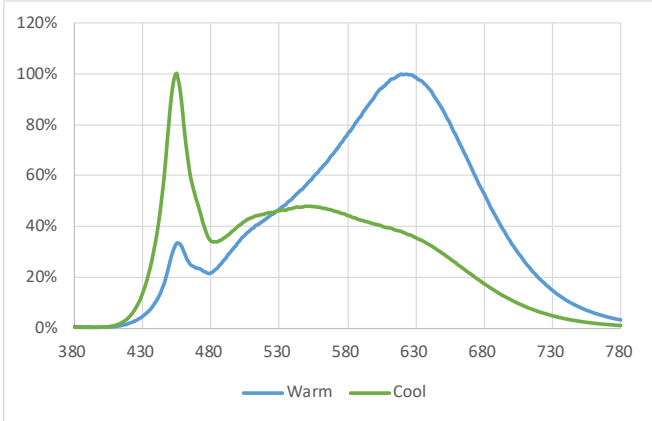

4018 Series

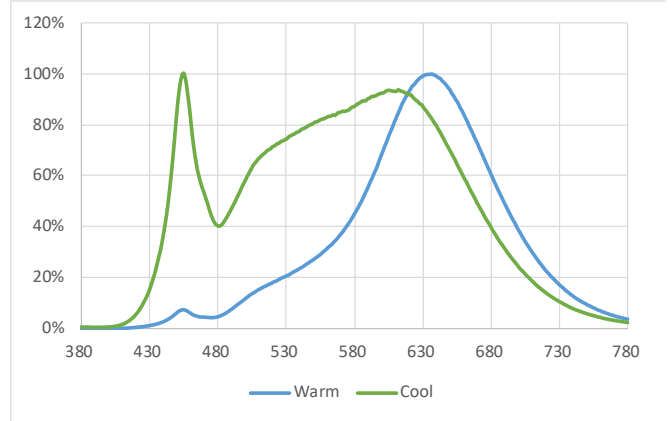

5022 Series

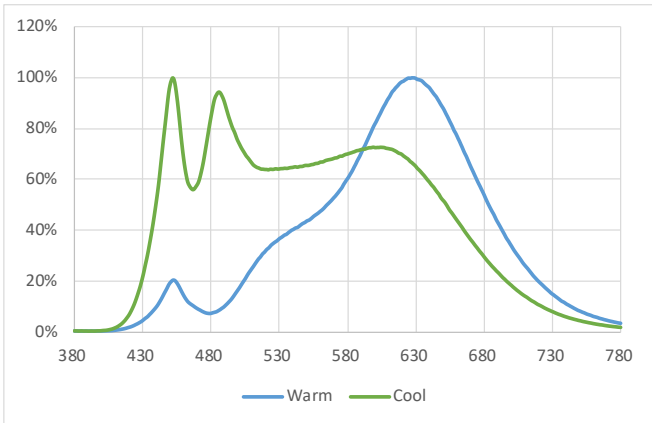



Mechanical Dimensions

CTM-6

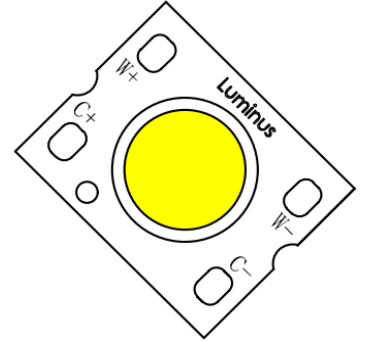
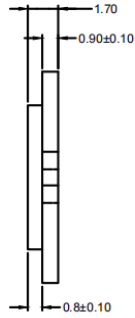
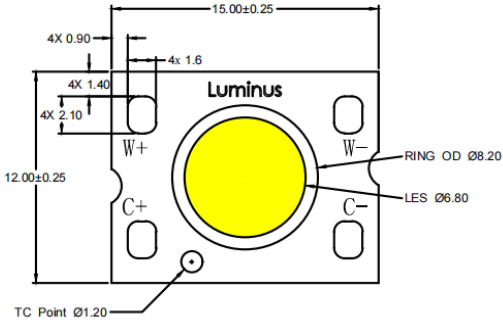

CTM-9

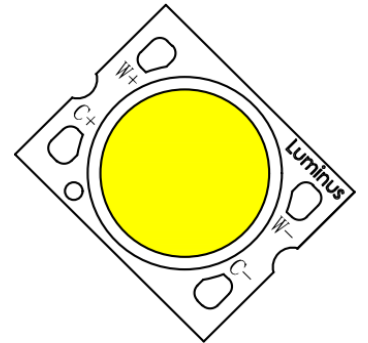
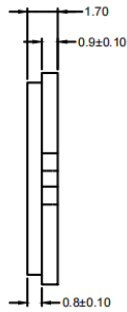
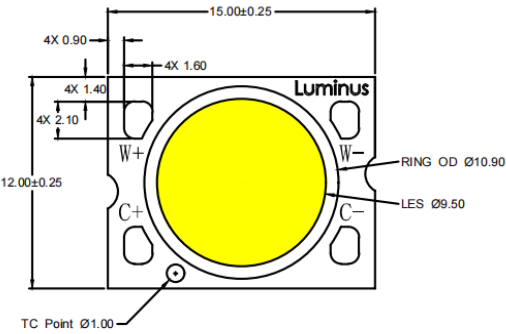

CTM-14

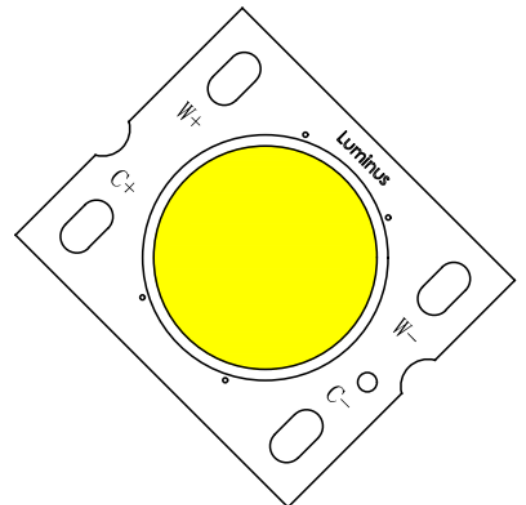
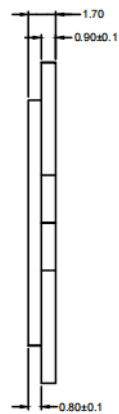
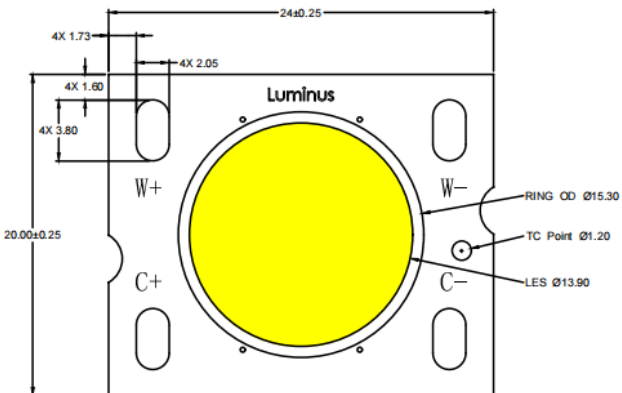



Mechanical Dimensions

CTM-18

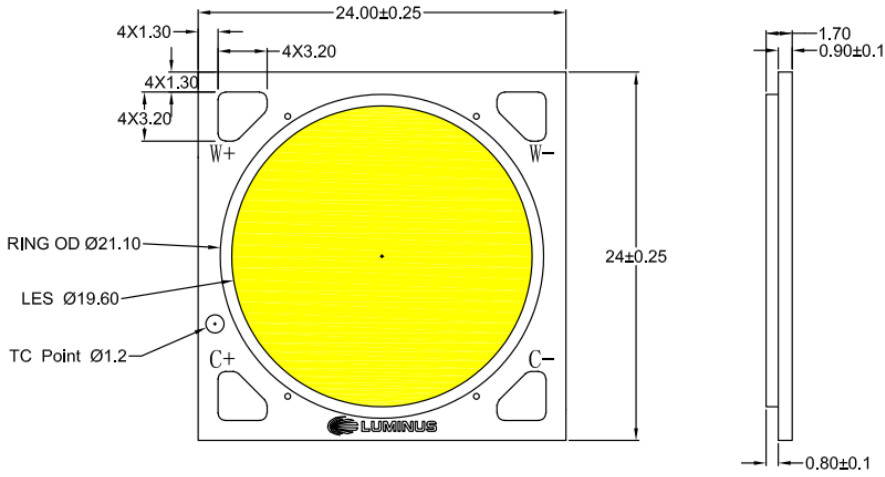

CTM-22

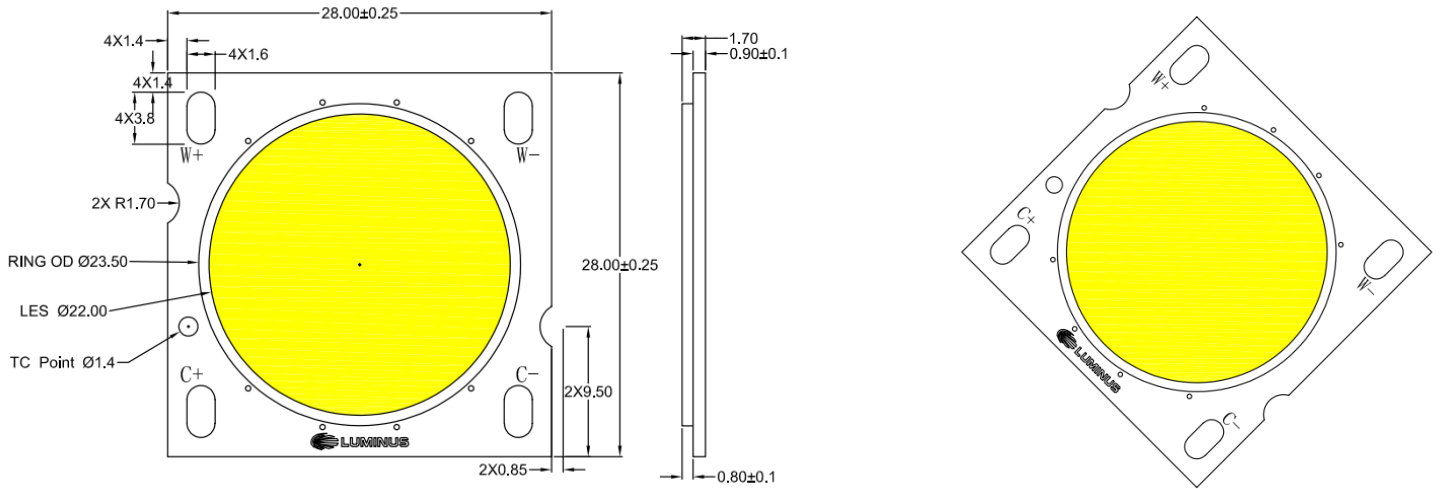



SHIPPING CONTAINER



Package model -- for Illustration



LES	Pcs/Tray	Tray/Small box	Small box/ Carton	Total
6mm/9mm	80	5	8	3200
14mm	35	5	8	1400
18mm	30	5	8	1200
22mm	20	5	8	800

Luminus Label Model:

		Luminus Devices Inc		RoHS Compliant
XXXXXX-XX-XX (Manufacturer Part Number & Bin Kits)	Rev XX	Bar code	Bar code	
XXX-XX-XX-XX-XX-XXXX-XX-X (Customer Part Number)	Qty: XX	Bar code	Bar code	
XXXXXXXXXXXXXXXX (Box ID)		Bar code	Bar code	



Technology Overview

Luminus Chip-on-Board (COB) LED series have consistently delivered the highest lumen performance with the best color quality of any COB supplier. Driving performance enhancements through more than 5 generations of COB products has provided Luminus a comprehensive understanding of the lighting market for directional sources positioning Luminus as the COB manufacturer of choice for the most discriminating lighting manufacturers.

Reliability

Designed from the ground up, the Luminus COB LED is one of the most reliable light sources in the world today.

UL and IEC Recognized Compliance

Luminus COB arrays are tested in accordance with ANSI/UL 8750 to ensure safe operation for their intended applications. Further, Luminus maintains IEC-62031 safety ratings on all COB products.

REACH & RoHS Compliance

All LED products manufactured by Luminus are REACH and RoHS compliant and free of hazardous materials, including lead and mercury.

Test Specifications

Every Luminus LED is fully tested to ensure it meets the high quality standards customers have come to expect from Luminus' products.

Traceability

Each Luminus COB LED is marked with a 2D bar code that contains a unique serial number. With this serial number, Luminus has the ability to provide customers with actual test data measurements for a specific LED. In addition, the 2D bar code is linked to manufacturing date codes that enables traceability of production processes and materials.

Testing Temperature

Luminus COB products are measured at temperatures typical for the LED operating in the fixture. Each device is tested at 85°C junction temperature eliminating the need to scale data sheet specifications to real world situations.

Chromaticity Bin Range

Chromaticity binning delivers color consistency for every order. Standard products are delivered with a 3-step MacAdam ellipse. This ensures color performance matching in the application. For the most demanding application, Luminus is one of only a few companies that can provide a 2 SDCM bin distribution. These tightly controlled, small distribution bins provide customers predictable, repeatable colors.



Handling Notes

Luminus products are designed for robust performance in general lighting application. However, care must be taken when handling and assembling the LEDs into their fixtures. To avoid damaging Luminus COBs please follow these guidelines.

The following is an overview of the application notes detailing some of the practices to follow when working with these devices. More detailed information is available on the Luminus web site at www.luminus.com.

General Handling

Devices are made to be lifted or carried with tweezers on two adjacent corners opposite the contact pads. At no time should the devices be handled by or should anything come in contact with the light emitting surface (LES) area. This area includes the yellow colored circular area and the ring surrounding it. There are electrical connections under the LES which if damaged will cause the device to fail. In addition, the ring frame itself should not be used for moving, lifting or carrying the device. Also do not attach any optics or mechanical holders to the ring as it is not capable to handle the mechanical stress.

Storage Condition

Please follow the conditions below.

Before opened	Temperature 5~30°C, relative humidity less than 60%.
After opened	Temperature 5~30°C, relative humidity less than 60%. After opening, LED should be kept in an aluminum moisture proof bag with a moisture absorbent material
Avoid Corrosive gas	Avoid exposing to air with corrosive gas. If exposed, electrode surface would be damaged, which may affect soldering. More detailed information is available on the Luminus Applications Resources web pages.

Static Electricity

Luminus COBs are electronic devices which can be damaged by electrostatic discharge (ESD). Please use appropriate measures to assure the devices do not experience ESD during their handling and or storage. ESD protection guidelines should be used at all time when working with Luminus COBs.

Storage	Luminus products are delivered in ESD shielded bags and should be stored in these bags until used
Transporting	When transporting the devices from one assembly area to another, ESD shielded carts and carriers should be used
Assembly	Individuals handling Luminus COBs during assembly should be trained in ESD protection practices. Assemblers should maintain constant conductive contact with a path to ground by means of a wrist strap, ankle straps, mat or other ESD protection system



Chemical Compatibility

The resin material used to form the LES can get hydrocarbons from the surrounding environment. As a result, certain chemical compounds (H₂SO₄, H₂S, SO₂, NH₃, H₃PO₄, , etc.) are not recommended for use with the Luminus products. Use of these compounds can cause damage to the light output of the device and may permanently damage the device. Please refer to the table below for a list of the compounds not recommended for use with the Luminus COB products.

Common Chemicals Know to Adversely Affect Luminus Devices		
Acetates	Ethers	Potassium hydroxide
Acetic acid	Cl, F or Br containing compounds	Siloxanes
Acrylates	Liquid hydrocarbons	Sodium Hydroxide
Aldehydes	Hydrochloric Acid	Sulfur compounds
Aldehydes	Ketones	Sulfuric Acid
Amines	Nitric Acid	Toluene
Benzene	Phosphoric acid	Xylenes
Dienes		

Thermal Interface Material (TIM)

Proper thermal management is critical for successful operation of any LED system. Excess operating temperature can reduce the light output of the device. And excessive heating can cause permanent damage to the device. Proper TIM material is a crucial component for effective heat transfer away from the LED during normal operation. Please refer to www.luminus.com for specific recommendations for TIM solutions.

Please refer to <https://www.luminus.com/resource/application-notes> for more application note information.